

ONGUARD ONE MEAN LOCK™

BICYCLE, SCOOTER
& POWER TRANSPORT
SECURITY

2023





Our PitBull Series U-locks were awarded the highest Sold Secure rating of DIAMOND!

ONGUARD
ONE MEAN
LOCK™



ONGUARD ONE MEAN LOCK™

OnGuard makes the meanest, toughest locks in the business. Packed with features inside and out, we deliver the best in security, value, and service. On the inside, OnGuard locks earn the highest safety ratings with double and quad-locking mechanisms, bump-resistant cylinders, and hardened steel shackles and chains. On the outside, our locks are fully-coated to protect your bicycle or powersport vehicle from scratches and to shield internal parts from the elements, while the bright color scheme sends a clear warning to thieves: don't even try! And then there's the extras: all-tube mounting brackets, five laser cut keys, key-code registration, comprehensive anti-theft programs, limited lifetime warranties and the best sales and customer support team in the business.

OUR SECURITY RATING SYSTEM



Comparing locks has never been easier.

Determine the security level needed:

RED - Ultimate security for inner city and high crime areas.

BLUE - High security for medium crime areas.

GREEN - Base security for low to moderate crime areas.

Use the numbers within the color level to compare locks.

The higher the number, the more security provided.

This makes selecting the right lock simple and intuitive with up-selling opportunity.

CONTENTS

- Technology 4
- Features 6
- U-Locks 8
- Chain Locks 18
- Armored Cable Locks 28
- Coil Cable Locks 32
- Key Alike Sets 39
- Cable Locks 40
- Small Cable Locks 46
- Padlocks 47
- Disc Locks 48
- Smart Alarm Series 52
- Link Plate locks 54
- Neon Series 56
- Lightweight Series 60
- eBike 62
- Cuff Locks 64
- Scooter locks 66
- FastLock Series 69
- ZIP Locks 70
- Solo Chains 71
- Ground Anchors 72
- Merchandisers 74



Pitbull Mini DT Bulldog Combo STD Brute LS Beast Mastiff Doberman Combo Doberman Rottweiler Akita

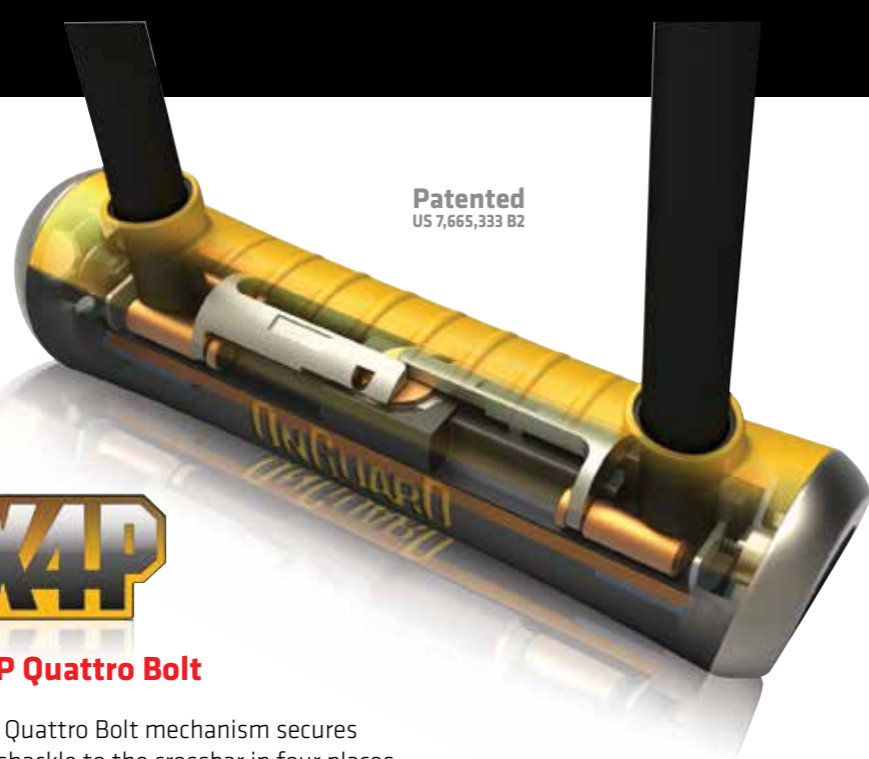

Patented
US 7,665,333 B2



X4P Quattro Bolt

X4P Quattro Bolt mechanism secures the shackle to the crossbar in four places maximizing strength to resist pulling, jacking, prying and twisting.



Pat. Pend.



X2P Dual Lock Down

Padlocks with X2P Dual Lock Down mechanisms secure both sides of the shackle for ultimate pull resistance.

**ONGUARD INNOVATION MEANS
MAXIMUM SECURITY**

A lock is only as good as it's weakest link. And where some locks secure only one side of the shackle, OnGuard's patented X4P Quattro Bolt, X2P Double Bolt and X2P Dual Lock Down mechanisms secure both sides for a double-redundant system that resists attack from pulling, jacking and prying. And OnGuard's user-settable SBC Steel Ball Combo locks feature a high security click gear system that resists picking and pulling. Simply put, OnGuard lock technology means maximum security.

- Shackle secured at both ends for a double-redundant system
- Both sides of shackle must be defeated to open lock
- Hardened steel throughout resists all forms of attack
- Round profiles and smooth edges eliminate leverage points

Patented
US 7,823,424 B2



X2P Double Bolt

Cable locks with X2P Dual Lock Down mechanisms secure cable to lock head in two places for high pull and pry resistance.

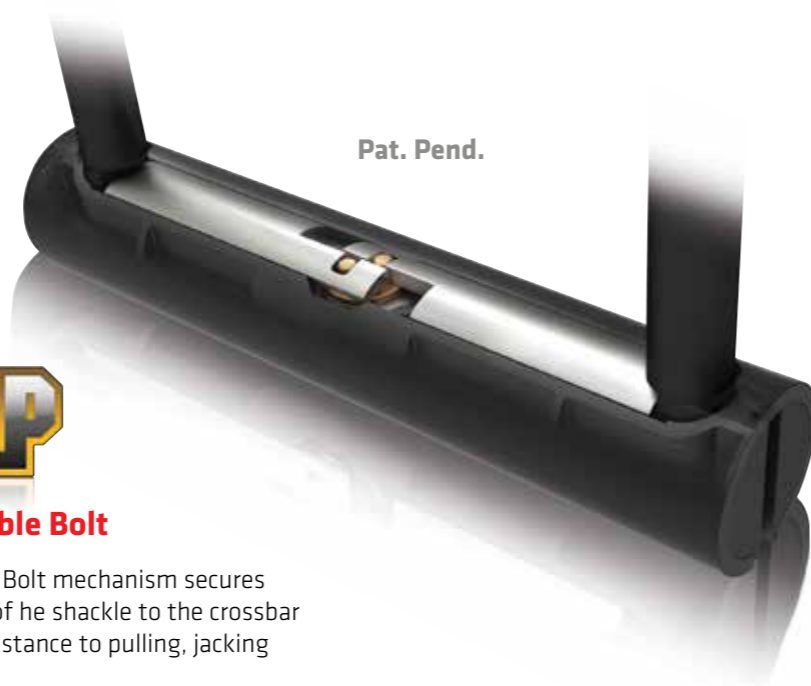

Pat. Pend.



X2P Double Bolt

X2P Double Bolt mechanism secures both sides of the shackle to the crossbar for high resistance to pulling, jacking and prying.



Pat. Pend.



Steel Ball Combo

Steel Ball Combo locks use a smooth running, steel ball click gear system that resists picking and pulling.

PROTECTION, FEATURES, VALUE- ONGUARD GIVES YOU MORE

Of course OnGuard locks offer the best security in the business. But beyond that OnGuard locks are packed with user-friendly, value added features that make closing the sale a slam dunk. From the

pick, pull, drill and bump-proof protection of the new Z-Cylinder to new double rubber coatings to the new Twist Lock mounting bracket, nobody gives you more than OnGuard.



Z-Cylinder

The Z-Cylinder offers high pick protection and feature BumpBlock™ technology rendering bump keys useless. Lock mechanism is encased in ultra-hardened steel to resist drilling or pulling.

- The unique construction makes the Z-Cylinder virtually pickproof
- BumpBlock renders bump keys useless
- Ultra-steel encased mechanism defeats drilling

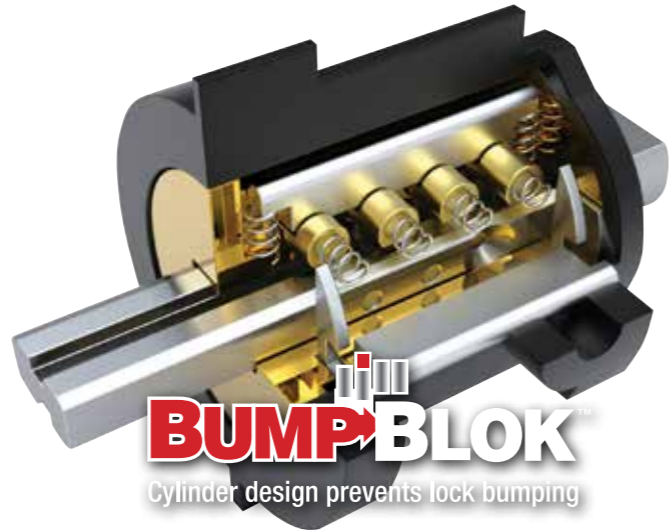

BUMPBLOCK
Cylinder design prevents lock bumping

Laser-cut Keys

Locks equipped with Z-Cylinder systems come standard with 4 laser-cut keys plus 1 micro-light key for night use and can be keyed alike with other OnGuard Z-Cylinder locks. In the event that

replacement keys are needed, simply call OnGuard and with your key code (or register online after purchase) and replacement keys can be sent to you for a minimal fee.



GLO - Combo

No more fumbling with combinations in the dark. Our Doberman and Terrier Combo Glo locks feature backlit tumblers for ease of use after dark.

*Models 8031GLO, 8061 & 8062



Snap Lock QR Bracket

OnGuard Cable Locks come equipped with our new TwistLock QR Mounting Bracket is a complete redesign offering improved ease-of use. Simply attach the universal mounting bracket to any tube, insert the lock "T" fixture and twist. To release push the orange release lever and twist. Carrying your lock has never been easier.



Snap Lock QR Bracket

OnGuard U-Locks and cable locks come equipped with a universal mounting bracket that works with any size bicycle tube (22mm-80mm). Plus, the versatile design allows for a variety of placement options- down tube, top tube, seat post, offset, whatever- eliminating interference with cables, water bottle cages or other accessories. Soft rubber interface won't harm bike's finish.

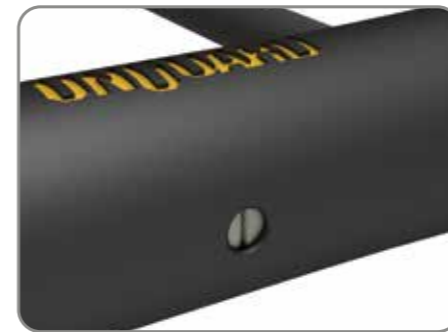

More Protection

New double rubber coatings on U-lock crossbars and shackles and cable lock heads help protect paint and finishes while metal and thick rubber end caps protect against bumps and hits. Z-Cylinders feature new automatic and manual keyway seals to keep water, dirt and grit out of lock internals. Overall tolerances are tighter for better fit and increased resistance to the elements. Chain covers are embroidered, not screened, for long lasting good looks and feature Velcro tabs to keep covers in place to protect paint and finishes. Cables feature tough vinyl coatings on both cable and swedging for long lasting durability and protection.

Perfectly suited for cyclists and power sport users, OnGuard U-Locks offer our highest level of security in one convenient, easy-to-use design. OnGuard's wide range of shackle lengths, optional cables, pick, pull, bump and drill resistant Z-Cylinders or convenient combination locks, there's an OnGuard U-Lock that's exactly right for your security needs.

OnGuard U-locks feature:

- X4 and X2 locking mechanisms secure both sides of the shackle
- Hardened steel shackles are impervious to prying, jacking, or cutting
- Round profile and smooth edges eliminate leverage points
- Fully coated shackles and crossbar protects delicate finishes and paint jobs



X4P Quattro Bolt

X4P Quattro Bolt mechanism secures the shackle to the crossbar in four places maximizing strength to resist pulling, jacking, prying and twisting.

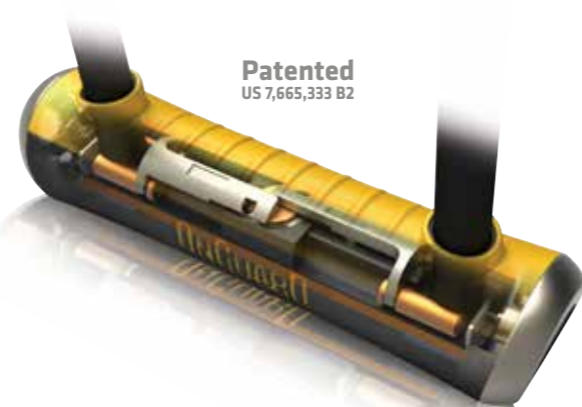

Patented
US 7,665,333 B2



X2P Double Bolt

X2P Double Bolt mechanism secures both sides of the shackle to the crossbar for high resistance to pulling, jacking and prying.



Pat. Pend.



Z-Cylinder

The Z-Cylinder offers high pick protection and feature BumpBlock™ technology rendering bump keys useless. Lock mechanism is encased in ultra-hardened steel to resist drilling or pulling.

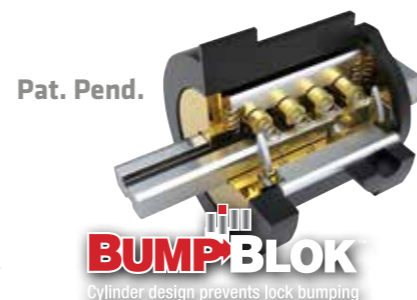

Pat. Pend.

BUMP BLOK
Cylinder design prevents lock bumping

ADDITIONAL FEATURES



Snap Lock Quick Release multi-position mounting bracket

5 laser cut keys (1 micro-light and 4 extra grip keys)

Micro-light key projects a bright white beam



Brute LS 8000 | 8000X Page 10 111 x 260mm [4.53 x 10.24"]
Brute STD 8001 | 8001X Page 11 115 x 202mm [4.53 x 7.96"]
Brute Mini 8112 | 8112X Page 11 90 x 140mm [3.55 x 5.52"]



Pitbull LS 8002 | 8002X Page 12 115 x 292mm [4.53 x 11.50"]
Pitbull STD 8003 | 8003X Page 12 115 x 230mm [4.53 x 9.06"]
Pitbull DT 8005 | 8005X Page 13 115 x 230mm [4.53 x 9.06"]

120cm x 10mm [4' x 0.39"]



Pitbull Mini 8006 | 8006X Page 13 90 x 140mm [3.55 x 5.52"]
Pitbull Medium 8006M | 8006MX Page 13 90 x 175mm [3.55 x 6.90"]
Pitbull Mini LS 8007 | 8007X Page 13 90 x 240mm [3.55 x 9.46"]
Pitbull Mini DT 8008 | 8008X Page 13 90 x 140mm [3.55 x 5.52"]

120cm x 10mm [4' x 0.39"]



Bulldog LS 8009 | Page 14 115 x 292mm [4.53 x 11.50"]
Bulldog STD 8010 | Page 14 115 x 230mm [4.53 x 9.06"]
Bulldog ATB 8011 | Page 14 127 x 230mm [5 x 9.06"]
Bulldog DT 8012 | Page 15 115 x 230mm [4.53 x 9.06"]
Bulldog Mini 8013 | Page 15 90 x 140mm [3.55 x 5.52"]

120cm x 10mm [4' x 0.39"]

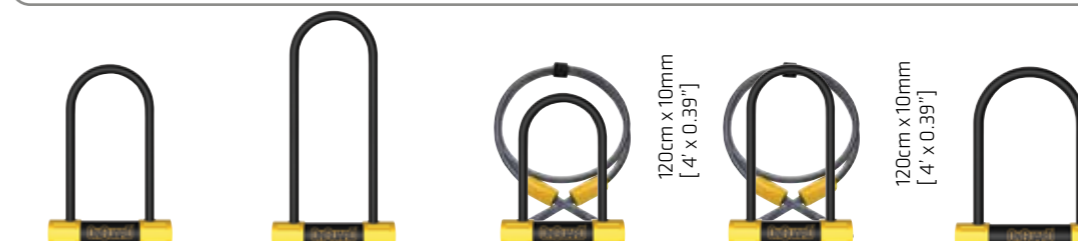

Bulldog Mini 7 8013M | Page 15 90 x 175mm [3.55 x 6.90"]
Bulldog Mini LS 8014 | Page 15 90 x 240mm [3.55 x 9.46"]
Bulldog Mini DT 8015 | Page 15 90 x 140mm [3.55 x 5.52"]
Bulldog Mini 7 8015M | Page 15 90 x 175mm [3.55 x 6.90"]
Bulldog STD LM 8010LM | Page 16 115 x 230mm [4.53 x 9.06"]

120cm x 10mm [4' x 0.39"]

120cm x 10mm [4' x 0.39"]

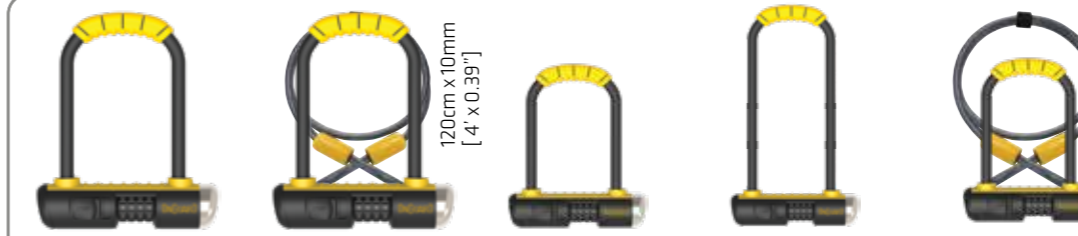

Bulldog Combo STD 8010C | Page 17 115 x 230mm [4.53 x 9.06"]
Bulldog Combo DT 8012C | Page 17 115 x 230mm [4.53 x 9.06"]
Combo Mini 8013C | Page 17 90 x 140mm [3.55 x 5.52"]
Combo Mini LS 8014C | Page 17 90 x 240mm [3.55 x 9.46"]
Combo Mini DT 8015C | Page 17 90 x 140mm [3.55 x 5.52"]

120cm x 10mm [4' x 0.39"]

120cm x 10mm [4' x 0.39"]

BRUTE SERIES

- X4 Quattro Bolt Locking Mechanism
- 16.8mm [0.66"] Hardened Steel Shackle

PITBULL SERIES

- X4 Quattro Bolt Locking Mechanism
- 14mm [0.55"] Hardened Steel Shackle

PITBULL SERIES

- X4 Quattro Bolt Locking Mechanism
- 14mm [0.55"] Hardened Steel Shackle

BULLDOG SERIES

- X2 Double Bolt Locking Mechanism
- 13mm [0.51"] Hardened Steel Shackle

BULLDOG SERIES

- X2 Double Bolt Locking Mechanism
- 11-13mm [0.43-0.51"] Hardened Steel Shackle

COMBO SERIES

- X2 Double Bolt Locking Mechanism
- 13mm [0.51"] Hardened Steel Shackle

BRUTE SERIES

Ultimate protection for high crime areas. X4P Quattro Locking Mechanism for 4-sided protection. Massive 16.8mm (0.66") hardened steel TriRadius shackle resists all forms of cutting, prying or jacking and provides extra room for more locking options. New crossbar and shackle coatings protect finishes.

- X4P Quattro Bolt Locking Mechanism locks shackle on four sides
- NEW Z-Cylinder is bump-proof and resists picking, pulling or drilling
- NEW TriRadius shackle creates more internal space for locking versatility
- Massive 16.8mm (0.66") hardened steel shackle resists cutting, prying and jacking
- Rounded design and centered keyway eliminates pry points
- NEW co-molded crossbar cover and double rubber coated shackle protects finishes
- NEW all-metal end caps provide additional protection against hits and drops
- NEW automatic keyway covers helps seal lock internals against the elements

Locking Mechanism: X4P Quattro Bolt
Tumbler Mechanism: Z-Cylinder, European Type
Shackle Diameter: 16.8mm (0.66")
Coatings: Hardened Steel, Co-molded Crossbar Cover with Metal End Caps, Double Rubber Coated Shackle Cover
Keyway: Automatic Weather Resistant
Keys: 5 Laser Cut Keys, 1 With LED Micro-light
Anti-Theft Plan: \$5001 Bicycle, \$1251 Powersport
Warranty: Lifetime
Extras: All-Tube Mounting Bracket Included

X4P Locks shown on this page feature X4P Quattro bolt locking mechanisms

BRUTE SERIES | 8000
ANTI-THEFT PROTECTION OFFER
 for power sport \$1251 for bicycle \$5001



ULTIMATE SECURITY SECURITY RATING 95
 10 20 30 40 50 60 70

Brute LS | 8000 | 8000X
 X4P Quattro Locking Mechanism for four-sided protection, longer 111x260mm (4.37x10.24") TriRadius shackle provides more locking options. Perfect for powersport applications.

Shackle Dimensions: 111mm x 260mm (4.53" x 10.24") x 16.8mm (0.66") D

ADDITIONAL FEATURES



Snap Lock Quick Release multi-position mounting bracket



5 laser cut keys (1 micro-light and 4 extra grip keys) Micro-light key projects a bright white beam

BRUTE SERIES | 8000
ANTI-THEFT PROTECTION OFFER
 for power sport \$1251 for bicycle \$5001



Locks shown on this page feature X4P Quattro bolt locking mechanisms



ULTIMATE SECURITY SECURITY RATING 95
 10 20 30 40 50 60 70

Brute STD | 8001 | 8001X

Maximum protection in a standard length shackle. X4P Quattro Locking Mechanism for 4-sided protection, TriRadius shackle design provides extra room for more locking options while remaining compact for easy transport.

Shackle Dimensions: 115mm x 202mm (4.53" x 7.96") x 16.8mm (0.66") D

ADDITIONAL FEATURES



Snap Lock Quick Release multi-position mounting bracket



5 laser cut keys (1 micro-light and 4 extra grip keys) Micro-light key projects a bright white beam

ULTIMATE SECURITY SECURITY RATING 95
 10 20 30 40 50 60 70

Brute Mini | 8112 | 8112X

Bike messengers and scooter owners will love the new TriRadius shackle design that provides increased space for more locking options yet will slip easily into a messenger bag.

Shackle Dimensions: 90mm x 140mm (3.55" x 5.52") x 16.8mm (0.66") D

PITBULL SERIES

Superior protection for medium to high crime areas. X4P Quattro Locking Mechanism for four-sided protection. Hefty 14mm (0.55") hardened steel TriRadius shackle resists cutting, prying and jacking while providing more internal space for locking versatility. New crossbar and shackle coatings protect finishes. provide increased locking versatility for securing bicycles and scooters.

- X4P Quattro Bolt Locking Mechanism locks shackle on four sides
- NEW Z-Cylinder is bump-proof and resists picking, pulling or drilling
- NEW TriRadius shackle creates more internal space for locking versatility
- Hefty 14mm (0.55") hardened steel shackle resists cutting, prying and jacking
- Rounded design and centered keyway eliminates pry points
- NEW co-molded crossbar cover and double rubber coated shackle protects finishes
- NEW all-metal end caps provide additional protection against hits and drops
- NEW automatic keyway covers helps seal lock internals against the elements

Locking Mechanism: X4P Quattro Bolt
Tumbler Mechanism: Z-Cylinder, European Type
Shackle Diameter: 14mm (0.55")
Coatings: Hardened Steel, Co-molded Crossbar Cover with metal end caps, Double Rubber Coated Shackle Cover
Keyway: Automatic Weather Resistant
Keys: 5 Laser Cut Keys, 1 With LED Micro-light
Anti-Theft Plan: \$2251 Bicycle, \$751 Powersport
Warranty: Lifetime
Extras: All-Tube Mounting Bracket Included

X4P Locks shown on this page feature X4P Quattro bolt locking mechanisms

PITBULL SERIES
ANTI-THEFT PROTECTION OFFER
 for power sport **\$751**
 for bicycle **\$2251**



ULTIMATE SECURITY SECURITY RATING 80
 10 20 30 40 50 60 70

PitBull LS | 8002 | 8002X
 X4P locking mechanism for ultimate protection with extra long 292mm (11.50") shackle length, perfect for scooter owners or anywhere high security and extra locking options are needed.
Shackle Dimensions: 115mm x 292mm (W x H x Diam)
 (4.53" x 11.50") x 14mm (0.55") D



ULTIMATE SECURITY SECURITY RATING 80
 10 20 30 40 50 60 70

PitBull STD | 8003 | 8003X
 The superior protection of our X4P locking mechanism mated to a standard length 230mm (9.06") 14mm (0.55") TriRadius hardened steel shackle for more locking options.

Shackle Dimensions: 115mm x 230mm (W x H x Diam)
 (4.53" x 9.06") x 14mm (0.55") D

ULTIMATE SECURITY SECURITY RATING 85
 10 20 30 40 50 60 70

PitBull DT | 8005 | 8005X
 PitBull STD double-teamed with 4 foot fully coated, braided steel cable allows user to leave front wheel on bike and extra locking versatility. X4P locking mechanism offers superior protection.

Shackle Dimensions: 115mm x 230mm (W x H x Diam)
 (4.53" x 9.06") x 14mm (0.55") D
Cable Dimensions: 120cm x 10mm (4' x 0.39")

ULTIMATE SECURITY SECURITY RATING 80
 10 20 30 40 50 60 70

PitBull Mini | 8006 | 8006X
 Lighter than Brute Mini but with the advantages of X4P Locking Mechanism. Perfect for fast commuters or bike messengers who are weight sensitive.

Shackle Dimensions: 90mm x 140mm (W x H x Diam)
 (3.55" x 5.52") x 14mm (0.55") D

ADDITIONAL FEATURES

- 5 laser cut keys (1 micro-light and 4 extra grip keys) Micro-light key projects a bright white beam
- Snap Lock Quick Release multi-position mounting bracket

X4P Locks shown on this page feature X4P Quattro bolt locking mechanisms



ULTIMATE SECURITY SECURITY RATING 80
 10 20 30 40 50 60 70

PitBull Medium | 8006M | 8006MX
 PitBull Mini crossbar with medium shackle length to fit around new standard parking meter posts. Great for bicycle messengers. X4P locking mechanism.

Shackle Dimensions: 90mm x 175mm (W x H x Diam)
 (3.55" x 6.90") x 14mm (0.55") D

ULTIMATE SECURITY SECURITY RATING 80
 10 20 30 40 50 60 70

PitBull Mini LS | 8007 | 8007X
 PitBull Mini with extra long shackle for more locking options. X4P Locking Mechanism.

Shackle Dimensions: 90mm x 240mm (W x H x Diam)
 (3.55" x 9.46") x 14mm (0.55") D

ULTIMATE SECURITY SECURITY RATING 85
 10 20 30 40 50 60 70

PitBull Mini DT | 8008 | 8008X
 PitBull Mini double teamed with a 4 foot fully coated, braided steel cable for extra locking versatility.

Shackle Dimensions: 90mm x 140mm (W x H x Diam)
 (3.55" x 5.52") x 14mm (0.55") D
Cable Dimensions: 120cm x 10mm (4' x 0.39")

ADDITIONAL FEATURES

- Snap Lock Quick Release multi-position mounting bracket
- 5 laser cut keys (1 micro-light and 4 extra grip keys) Micro-light key projects a bright white beam

BULLDOG SERIES

Our best selling U-locks featuring best-in-class X2P Double Bolt lock mechanisms and super strong 13mm (0.51") hardened steel shackles for a full circle of protection.

- X2P Double Bolt Locking Mechanism locks shackle on both sides
- NEW Z-Cylinder is bump-proof and resists picking, pulling or drilling
- Hefty 13mm (0.51") hardened steel shackle resists cutting, prying and jacking
- Rounded design and centered keyway eliminates pry points
- NEW double rubber coated crossbar cover protects paint and finishes
- NEW extra thick molded end caps protects against bumps and hits

Locking Mechanism: X2P Double Bolt
Tumbler Mechanism: Z-Cylinder, European Type
Shackle Diameter: 13mm (0.51")
Coatings: Hardened Steel Double Rubber Coated crossbar with extra thick end caps, fully rubber coated shackle
Keys: 5 laser-cut keys, 1 with LED micro-light
Anti-Theft Plan: \$1501 Bicycle, \$501 Powersport
Warranty: Lifetime
Extras: All-Tube Mounting Bracket Included



X2P Locks shown on this page feature X2P Double Bolt Locking mechanisms



Bulldog STD | 8010
 Standard shackle length with X2P Double Bolt protection.

Shackle Dimensions: 115mm x 230mm (W x H x Diam)
 (4.53" x 9.06") x 13mm (0.51") D



Bulldog ATB | 8011
 A wider crossbar dimension - 127mm (5.0") - provides extra room for securing ATBs, and scooters. X2P Double Bolt Locking Mechanism offers best-in-class protection.

Shackle Dimensions: 127mm x 230mm (W x H x Diam)
 (5" x 9.06") x 13mm (0.51") D



Bulldog LS | 8009
 X2P Double Bolt Locking Mechanism offers best-in-class protection, long shackle provides more locking options.

Shackle Dimensions: 115mm x 292mm (W x H x Diam)
 (4.53" x 11.50") x 13mm (0.51") D

ADDITIONAL FEATURES

Snap Lock Quick Release multi-position mounting bracket

5 laser cut keys (1 micro-light and 4 extra grip keys) Micro-light key projects a bright white beam



Bulldog DT | 8012
 Bull Dog STD double-teamed with fully coated 4' braided steel cable for extra locking options.

Shackle Dimensions: 115mm x 230mm (W x H x Diam)
 (4.53" x 9.06") x 13mm (0.51") D

Cable Dimensions: 120cm x 10mm (4' x 0.39")

X2P Locks shown on this page feature X2P Double Bolt Locking mechanisms

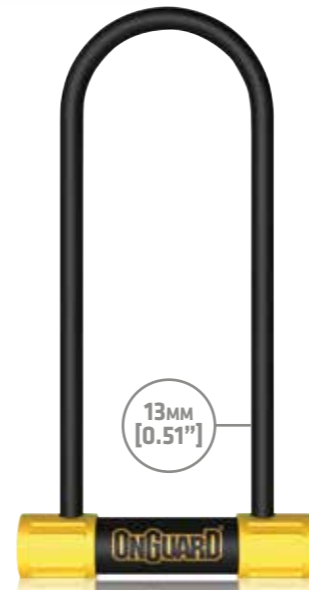

Bulldog Mini LS | 8014
 Bulldog Mini with longer 240mm (9.46") shackle for more locking versatility.

Shackle Dimensions: 90mm x 240mm (W x H x Diam)
 (3.55" x 9.46") x 13mm (0.51") D

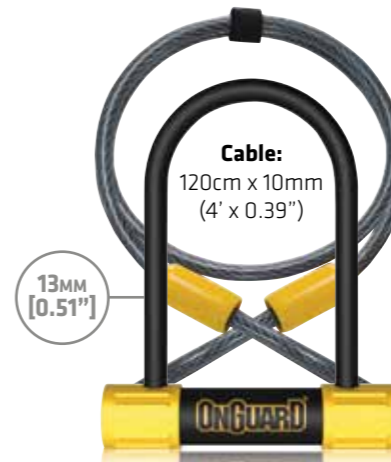

Bulldog Mini DT | 8015
 Bulldog Mini with 4 foot fully coated, braided steel cable for greater locking versatility.

Shackle Dimensions: 90mm x 140mm (W x H x Diam)
 (3.55" x 5.52") x 13mm (0.51") D
Cable Dimensions: 120cm x 10mm (4' x 0.39")

ADDITIONAL FEATURES

5 laser cut keys (1 micro-light and 4 extra grip keys) Micro-light key projects a bright white beam

Snap Lock Quick Release multi-position mounting bracket



Bulldog Mini | 8013
 Bulldog level protection in a compact design. For those who travel light and fast but need the extra security of a X2P Double Bolt lock.

Shackle Dimensions: 90mm x 140mm (W x H x Diam)
 (3.55" x 5.52") x 13mm (0.51") D



Bulldog Medium | 8013M
 Shorter shackle and narrower crossbar fits around new standard parking meter posts, perfect for bike messengers or others who make repeated stops in urban environments.

Shackle Dimensions: 90mm x 175mm (W x H x Diam)
 (3.55" x 6.90") x 13mm (0.51") D

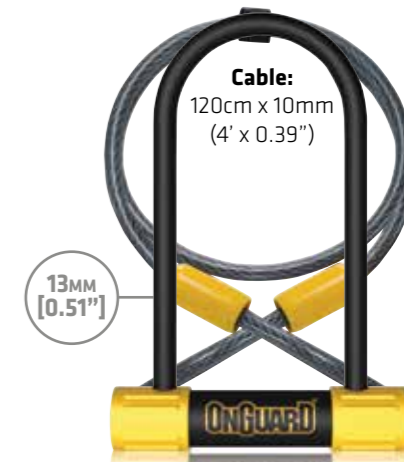

Bulldog Medium DT | 8015M
 7" shackle combined with 4' braided steel cable let's you lock bike to standard parking meter post without removing front wheel.

Shackle Dimensions: 90mm x 175mm (W x H x Diam)
 (3.55" x 6.90") x 13mm (0.51") D
Cable Dimensions: 120cm x 10mm (4' x 0.39")

BULLDOG SERIES

Our best selling U-locks featuring best-in-class X2P Double Bolt lock mechanisms and super strong 11-13mm (0.43-0.51") hardened steel shackles for a full circle of protection.

- X2P Double Bolt Locking Mechanism locks shackle on both sides
- NEW Z-Cylinder is bump-proof and resists picking, pulling or drilling
- Hefty 11mm (0.43") hardened steel shackle resists cutting, prying and jacking
- Rounded design and centered keyway eliminates pry points
- NEW double rubber coated crossbar cover protects paint and finishes
- NEW extra thick molded end caps protects against bumps and hits

Locking Mechanism: X2P Double Bolt Z-Cylinder, European Type
Tumbler Mechanism: X2P Double Bolt Z-Cylinder, European Type
Shackle Diameter: 11mm (0.43")
Coatings: Hardened Steel Double Rubber Coated crossbar with extra thick end caps, fully rubber coated shackle
Keys: 5 laser-cut keys, 1 with LED micro-light
Warranty: Lifetime
Extras: All-Tube Mounting Bracket Included

ADDITIONAL FEATURES

Snap Lock Quick Release multi-position mounting bracket

5 laser cut keys (1 micro-light and 4 extra grip keys)
 Micro-light key projects a bright white beam



BULLDOG SERIES | 8010LM
ANTI-THEFT PROTECTION OFFER for bicycle **\$501**

11MM [0.43"]

X2P Locks shown on this page feature X2P Double Bolt Locking mechanisms

HIGH SECURITY SECURITY 60 RATING 10 20 30 40 60 80 90 100

Bulldog STD LM | 8010LM
 Standard shackle length with X2P Double Bolt protection.

Shackle Dimensions: 115mm x 230mm (W x H x Diam)
 (4.53" x 9.06") x 11mm (0.43") D



HIGH SECURITY SECURITY 65 RATING 10 20 30 40 60 80 90 100

Combo STD | 8010C
 Popular shackle length with X2P Double Bolt protection combined with improved user-settable steel ball click-combo lock system.

Shackle Dimensions: 115mm x 230mm (W x H x Diam)
 (4.53" x 9.06") x 13mm (0.51") D

COMBO SERIES | 8010C, 8012C
ANTI-THEFT PROTECTION OFFER for power sport **\$501** for bicycle **\$1501**



HIGH SECURITY SECURITY 65 RATING 10 20 30 40 60 80 90 100

Combo Mini | 8013C
 Compact shackle length with X2P Double Bolt protection combined with improved user-settable steel ball click-combo lock system.

Shackle Dimensions: 90mm x 140mm (W x H x Diam)
 (3.55" x 5.52") x 13mm (0.51") D



HIGH SECURITY SECURITY 70 RATING 10 20 30 40 60 80 90 100

Combo DT | 8012C
 Convenience and security of Bulldog Combo STD with included 4 foot fully coated, braided steel cable for more locking options.

Shackle Dimensions: 115mm x 230mm (W x H x Diam)
 (4.53" x 9.06") x 13mm (0.51") D
Cable Dimensions: 120cm x 10mm (4' x 0.39")

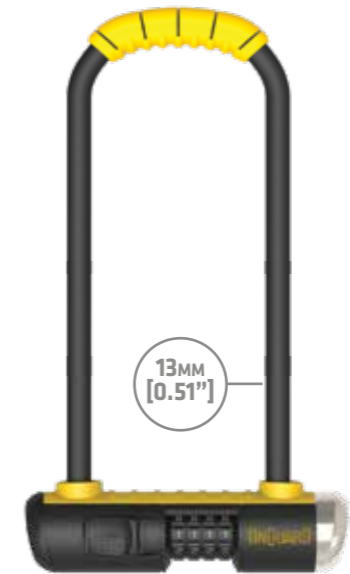

HIGH SECURITY SECURITY 70 RATING 10 20 30 40 60 80 90 100

Combo Mini LS | 8014C
 Combo Mini with longer 240mm (9.46") shackle for more locking versatility.

Shackle Dimensions: 90mm x 240mm (W x H x Diam)
 (3.55" x 9.46") x 13mm (0.51") D
Cable Dimensions: 120cm x 10mm (4' x 0.39")

COMBO SERIES

- X2P Double Bolt Locking Mechanism locks shackle on both sides
- Combo u-locks feature steel ball Click-Combo-Gear System that's user settable with 10,000 possible variations
- Hefty 13mm (0.51") hardened steel shackle resists cutting, prying and jacking
- NEW double rubber coated crossbar cover protects paint and finishes

X2P Locks shown on this page feature X2P Double Bolt Locking mechanisms

SBC Locks shown on this page feature Steel Ball Click-Combo-Gear System

ADDITIONAL FEATURES

Snap Lock Quick Release multi-position mounting bracket



HIGH SECURITY SECURITY 70 RATING 10 20 30 40 60 80 90 100

Combo Mini DT | 8015C
 Convenience and security of Bulldog Combo Mini with included 4 foot fully coated, braided steel cable for more locking options.

Shackle Dimensions: 90mm x 140mm (W x H x Diam)
 (3.55" x 5.52") x 13mm (0.51") D
Cable Dimensions: 120cm x 10mm (4' x 0.39")

OnGuard chain locks offer bicycle owners and powersport enthusiasts extra length for locking versatility plus the highest level of security for use in high crime areas. Massive, titanium reinforced hexagonal links render hacksaws and bolt cutters virtually useless while tight inside link dimensions make prying impossible. Available in a wide variety of chain lengths and link sizes to match your security needs.

OnGuard Chain locks feature:

- Hexagonal and square links present more hardened surfaces than round links making sawing and cutting virtually impossible.
- Titanium surface hardening vastly increase cut and saw resistance.
- Embroidered nylon chain covers won't crack or peel for long lasting beauty.
- Velcro tabs keep cover in place to help protect paint and finishes.
- Comprehensive selection of locks types, chain lengths and link size to exactly match security needs.



Z-Cylinder

The Z-Cylinder offers high pick protection and feature BumpBlock™ technology rendering bump keys useless. Lock mechanism is encased in ultra-hardened steel to resist drilling or pulling.

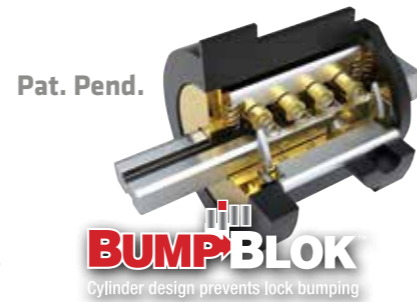

X2P Double Bolt

Cable locks with X2P Dual Lock Down mechanisms secure cable to lock head in two places for high pull and pry resistance.

Patented
US 7,823,424 B2



X4P Quattro Bolt

X4P Quattro Bolt mechanism secures the shackle to the crossbar in four places maximizing strength to resist pulling, jacking, prying and twisting.

Patented
US 7,665,333 B2

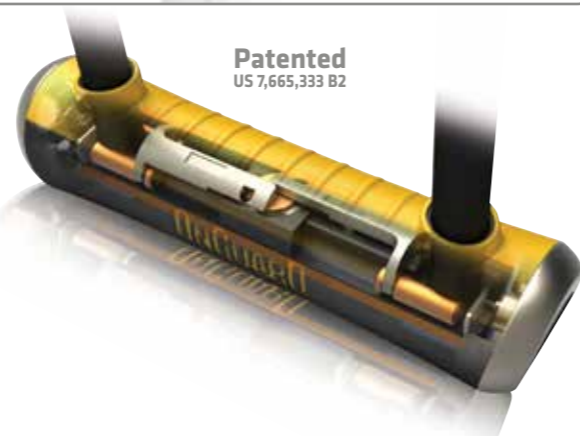

X2P Dual Lock Down

Padlocks with X2P Dual Lock Down mechanisms secure both sides of the shackle for ultimate pull resistance



ADDITIONAL FEATURES



5 laser cut keys
(1 micro-light and 4 extra grip keys)
Micro-light key projects a bright white beam



BEAST SERIES

- X4 Quattro Bolt Locking Mechanism / X2 Power Dual Lock Down
- 12-14mm [0.47-0.55"] Titanium enforced hardened steel chain
- Hexagonal chain links
- Embroidered nylon chain cover



BEAST SERIES

- X2 Double Bolt Locking Mechanism
- 12mm [0.47"] Titanium enforced hardened steel chain
- Hexagonal chain links
- Embroidered nylon chain cover

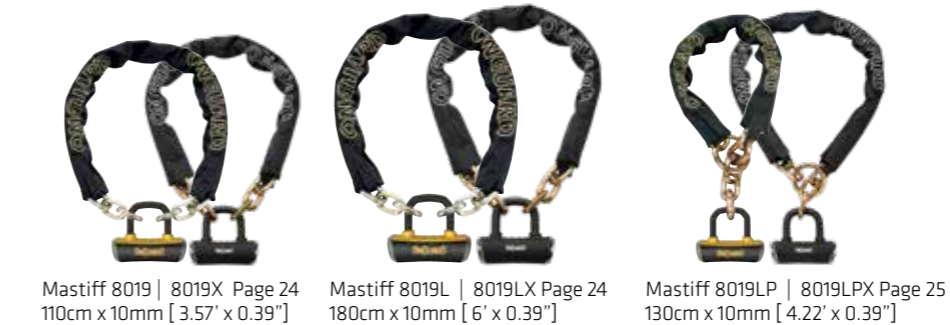

MASTIFF SERIES

- X4 Quattro Bolt Locking Mechanism
- 10mm [0.39"] Titanium enforced hardened steel chain
- Hexagonal chain links
- Embroidered nylon chain cover



MASTIFF SERIES

- X2 Double Bolt Locking Mechanism
- X2 Power Dual Lock Down
- 4-10mm [0.16-0.39"] Titanium enforced hardened steel chain
- Square chain links
- Embroidered nylon chain cover



MASTIFF SERIES

- X2 Double Bolt Locking Mechanism
- X2 Power Dual Lock Down
- 4-10mm [0.16-0.39"] Titanium enforced hardened steel chain
- Square chain links
- Embroidered nylon chain cover

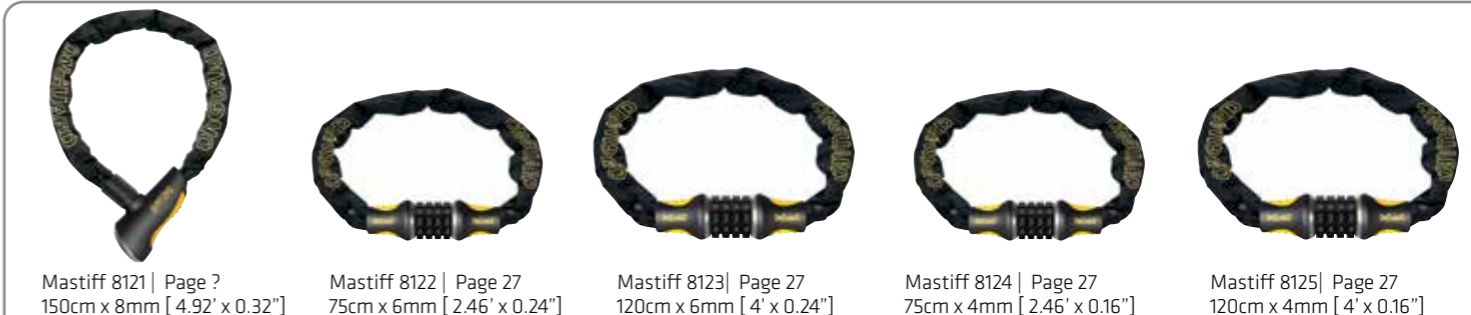

MASTIFF SERIES

- X2 Double Bolt Locking Mechanism
- X2 Power Dual Lock Down
- 4-10mm [0.16-0.39"] Titanium enforced hardened steel chain
- Square chain links
- Embroidered nylon chain cover

BEAST SERIES

- X4P Quattro Bolt Locking Mechanism locks shackle on four sides
- NEW Z-Cylinder is bump-proof and resists picking, pulling or drilling
- Massive 16.8mm (0.66") hardened steel shackle resists cutting, prying and jacking
- Rounded design and centered keyway eliminates pry points
- NEW co-molded crossbar cover and double rubber coated shackle protects finishes
- NEW all-metal end caps provide additional protection against hits and drops
- NEW automatic keyway covers helps seal lock internals against the elements
- 14mm (0.55") titanium reinforced, hardened steel hexagonal link chain resists cutting or prying
- Chain cover protects paint and finishes, embroidered logo won't flake or wear off
- Boxer U-lock can also be used as a disc lock

Locking Mechanism: X4P Quattro Bolt Z-Cylinder,
Tumbler Mechanism: European Type
Shackle Diameter: 16.8mm (0.66")
 Hardened Steel
Coatings: Co-molded Crossbar Cover with Metal End Caps
Keyway: Automatic Weather Resistant
Keys: 5 Laser Cut Keys, 1 With LED Micro-light
Anti-Theft Plan: \$5001 bicycle, \$1401 Powersport
Warranty: Lifetime
Extras: Embroidered chain cover



ULTIMATE SECURITY SECURITY RATING 10 20 30 40 50 60 70 **99**

Beast | 8016 | 8016X

X4P Boxer short shackle U-lock mated to a 3.5' chain with massive 14mm (0.55") link titanium reinforced chain. Perfect for powersport users who travel fast but need maximum protection for high crime areas. Boxer U-lock can also be used alone as a disc lock.

Chain Dimensions: 110cm x 14mm (3.57' x 0.55")
Shackle Diameter: 16.8mm (0.66")
 Hardened Steel

Locks shown on this page feature X4P Quattro bolt locking mechanisms



ULTIMATE SECURITY SECURITY RATING 10 20 30 40 50 60 70 **99**

Beast | 8016L | 8016LX

Same protection features as our awesome Beast 5016 with a longer 6-foot titanium reinforced, hardened steel chain; perfect for use with trailers, racks or anywhere a longer length, ultra-high security option is needed. Boxer U-lock can also be used alone as a disc lock.

Chain Dimensions: 180cm x 14mm (6' x 0.55")
Shackle Diameter: 16.8mm (0.66")
 Hardened Steel

BEAST SERIES | 8016, 8016L
ANTI-THEFT PROTECTION OFFER

for power sport **\$1401** for bicycle **\$5001**

ADDITIONAL FEATURES



5 laser cut keys (1 micro-light and 4 extra grip keys)
 Micro-light key projects a bright white beam



ULTIMATE SECURITY SECURITY RATING 10 20 30 40 50 60 70 **95**

Beast | 8017

12mm chain and NEW Beast with X2P Dual Lock Down design offer ultimate protection in a lighter, more compact design.

Chain Dimensions: 110cm x 12mm (3.57' x 0.47")
Shackle Diameter: 11mm (0.43")
 Hardened Steel

Locks shown on this page feature X2P Dual lock down mechanisms



ULTIMATE SECURITY SECURITY RATING 10 20 30 40 50 60 70 **95**

Beast | 8018

Longer 6' chain for more locking options, perfect for scooters and motorcycles or anywhere extra length is desired. New Beast lock with X2P Dual Lock Down protection.

Chain Dimensions: 180cm x 12mm (6' x 0.47")
Shackle Diameter: 11mm (0.43")
 Hardened Steel

- X2P Dual Lock Down Mechanism secure both sides of the shackle for ultimate pull resistance
- NEW Z-Cylinder is bump-proof and resists picking, pulling or drilling
- Rounded design and centered keyway eliminates pry points
- NEW co-molded crossbar cover and double rubber coated shackle protects finishes
- NEW all-metal end caps provide additional protection against hits and drops
- NEW automatic keyway covers helps seal lock internals against the elements
- 12mm (0.47") titanium reinforced, hardened steel hexagonal link chain resists cutting or prying
- Chain cover protects paint and finishes, embroidered logo won't flake or wear off

Locking Mechanism: X2P Dual Lock Down
Tumbler Mechanism: Z-Cylinder, European Type
Shackle Diameter: 11mm (0.43")
 Hardened Steel
Coatings: Co-molded Crossbar Cover with Metal End Caps
Keyway: Automatic Weather Resistant
Keys: 5 Laser Cut Keys, 1 With LED Micro-light
Anti-Theft Plan: \$3501 bicycle, \$1001 Powersport
Warranty: Lifetime
Extras: Embroidered chain cover

BEAST SERIES | 8017, 8018
ANTI-THEFT PROTECTION OFFER

for power sport **\$1001** for bicycle **\$3501**

ADDITIONAL FEATURES



5 laser cut keys (1 micro-light and 4 extra grip keys)
 Micro-light key projects a bright white beam

BEAST SERIES

- X2P Double Bolt Locking Mechanism
- NEW Z-Cylinder is bump-proof and resists picking, pulling or drilling
- NEW all-metal end caps provide additional protection against hits and drops
- NEW automatic keyway covers helps seal lock internals against the elements
- 12mm (0.47") titanium reinforced, hardened steel hexagonal link chain resists cutting or prying
- Chain cover protects paint and finishes, embroidered logo won't flake or wear off

Locking Mechanism: X2P Double Bolt
Tumbler Mechanism: Z-Cylinder, European Type
Rod Diameter: 16mm (0.63")
 Hardened Steel
Coatings: Co-molded Crossbar Cover with Metal End Caps
Keyway: Automatic Weather Resistant
Keys: 5 Laser Cut Keys, 1 With LED Micro-light
Anti-Theft Plan: \$1401 Powersport
Warranty: Lifetime
Extras: Embroidered chain cover



The lock shown on this page feature X2P Double Bolt Locking mechanism

ADDITIONAL FEATURES



5 laser cut keys
 (1 micro-light and 4 extra grip keys)
 Micro-light key projects a bright white beam

BEAST SERIES | 8017LPT
ANTI-THEFT PROTECTION OFFER for power sport
\$1401



Beast | 8017LPT

Maximum security in a super versatile "loop and T" design. Simply loop the chain around a solid fixture and then slip the massive 16mm hardened steel rod through an opening on your motorcycle, scooter, ATV, whatever, and lock the T. New Beast LPT body is double rubber coated to fit comfortably in hand and provides extra protection against bumps and hits.

Chain Dimensions: 140cm x 12mm (4.54' x 0.47")
Rod Diameter: 16mm (0.63")
 Hardened Steel



Beast | 8018L

Extra long 7' 12mm (0.47") chain mated to New Beast lock with X2P Dual Lock Down protection.

Chain Dimensions: 210cm x 12mm (7' x 0.47") chain only



BEAST SERIES | 8018L
ANTI-THEFT PROTECTION OFFER

for power sport **\$1001** for bicycle **\$3501**

* Anti-Theft protection offer only applies if used with an OnGuard Padlock 8101 or Disk Lock 8046.

WORKS WELL WITH



◀ **Beast Padlock | 8101**
 The lock shown on this page feature X2P Double Bolt Locking mechanism

Boxer | 8046 ▶
 The lock shown on this page feature X4P Quattro Bolt Locking mechanism



MASTIFF SERIES

- X4P Quattro Bolt Locking Mechanism locks shackle on four sides
- NEW Z-Cylinder is bump-proof and resists picking, pulling or drilling
- Rounded design and centered keyway eliminates pry points
- NEW co-molded crossbar cover and double rubber coated shackle protects finishes
- NEW all-metal end caps provide additional protection against hits and drops
- NEW automatic keyway covers helps seal lock internals against the elements
- 10mm (0.39") titanium reinforced, hardened steel hexagonal link chain resists cutting or prying
- Chain cover protects paint and finishes, embroidered logo won't flake or wear off
- Boxer U-lock can also be used as a disc lock

Locking Mechanism: X4P Quattro Bolt
Tumbler Mechanism: Z-Cylinder, European Type
Shackle Diameter: 14mm (0.55")
Coatings: Hardened Steel
Keyway: Co-molded Crossbar Cover with Metal End Caps
Automatic Weather Resistant
Keys: 5 Laser Cut Keys, 1 With LED Micro-light
Anti-Theft Plan: \$3001 bicycle, \$1001 Powersport
Warranty: Lifetime
Extras: Embroidered chain cover



Mastiff | 8019 | 8019X
 A short-shackle Boxer U-lock with X4P Quattro Bolt locking mechanism paired to a 3.5-foot long, 10mm (0.39") titanium reinforced, hardened steel hexagonal link chain. Boxer U-lock can also be used alone as a disc lock.

Chain Dimensions: 110cm x 10mm (3.57' x 0.39")
Shackle Diameter: 14mm (0.55")
 Hardened Steel



Locks shown on this page feature X4P Quattro bolt locking mechanisms



Mastiff | 8019L | 8019LX
 Longer 6' 10mm (0.39") titanium reinforced, hardened steel hexagonal link chain for more locking options. Boxer U-lock can also be used alone as a disc lock.

Chain Dimensions: 180cm x 10mm (6' x 0.39")
Shackle Diameter: 14mm (0.55")
 Hardened Steel



Mastiff | 8019LP | 8019LPX
 4.22' 10mm (0.39") hexagonal link chain length saves weight yet clever cinch-loop design adds locking versatility. Short shackle Boxer U-lock with X4P Quattro Bolt locking mechanism eliminates pry points for superior protection. Boxer U-lock can also be used alone as a disc lock.

Chain Dimensions: 130cm x 10mm (4.22' x 0.39")
Shackle Diameter: 14mm (0.55")
 Hardened Steel

MASTIFF SERIES | 8019LP
ANTI-THEFT PROTECTION OFFER

for power sport \$1001 for bicycle \$3001

MASTIFF SERIES | 8019, 8019L
ANTI-THEFT PROTECTION OFFER

for power sport \$1001 for bicycle \$3001

ADDITIONAL FEATURES



5 laser cut keys (1 micro-light and 4 extra grip keys)
 Micro-light key projects a bright white beam

ADDITIONAL FEATURES



5 laser cut keys (1 micro-light and 4 extra grip keys)
 Micro-light key projects a bright white beam

MASTIFF SERIES

- X2P Double Bolt Locking Mechanism
- NEW Z-Cylinder is bump-proof and resists picking, pulling or drilling
- NEW all-metal end caps provide additional protection against hits and drops
- NEW automatic keyway covers helps seal lock internals against the elements
- 10mm (0.39") titanium reinforced, hardened steel square link chain resists cutting or prying
- Chain cover protects paint and finishes, embroidered logo won't flake or wear off

Locking Mechanism: X2P Double Bolt Z-Cylinder, European Type
Tumbler Mechanism: Co-molded Crossbar Cover with Metal End Caps
Coatings: Automatic Weather Resistant
Keyway: 5 Laser Cut Keys, 1 With LED Micro-light
Keys: \$2001 bicycle, \$501 Powersport
Anti-Theft Plan: Lifetime
Warranty: Embroidered chain cover
Extras:



The lock shown on this page feature X2P Double Bolt Locking mechanism

MASTIFF SERIES | 8020, 8021, 8117, 8118

ANTI-THEFT PROTECTION OFFER

for power sport **\$501** for bicycle **\$2001**

MASTIFF SERIES | 8119, 8120, 8121, 8122

ANTI-THEFT PROTECTION OFFER

for power sport **\$501** for bicycle **\$1501**



Mastiff | 8020

3.5' 10mm (0.39") titanium reinforced hardened square link chain mated to an integrated X2P Dual Lock Down head featuring new double rubber cover for better protection against bumps and hits.

Chain Dimensions: 110cm x 10mm (3.57' x 0.39")



Mastiff | 8021

Longer 6' 10mm (0.39") titanium reinforced hardened square link chain with X2P Dual Lock Down head.

Chain Dimensions: 180cm x 10mm (6' x 0.39")



- Combo locks feature steel ball Click-Combo-Gear System that's user settable with 10,000 possible variations.
- NEW all-metal end caps provide additional protection against hits and drops
- 4-8mm (0.16-0.39") titanium reinforced, hardened steel square link chain resists cutting or prying
- Chain cover protects paint and finishes, embroidered logo won't flake or wear off

Note: Set your own four digit combination (10,000 variations) so no keys to lose or forget.



Locks shown on this page feature Steel Ball Click-Combo-Gear System



Mastiff | 8022C

User settable Steel Ball Combo lock is permanently forged to compact 2.5' 8mm (0.32") titanium reinforced hardened steel square link chain.

Chain Dimensions: 80cm x 8mm (2.59' x 0.32")



- Deadbolt Locking Mechanism for highest break resistance
- Armor protected hardened steel shackle for extra cut resistance
- 5 pin cylinder for extra pick resistance, heavy duty stainless steel body with massive inner base for enhanced security
- Rotary style lock provides smooth, one-handed operation
- Tight shackle-to-body clearance eliminates pry points and makes cutting difficult
- 5 heavy-duty F-style keys
- 8mm (0.32") titanium reinforced, hardened steel square link chain resists cutting or prying
- Chain cover protects paint and finishes, embroidered logo won't flake or wear off



Mastiff | 8117

2.3' 10mm (0.39") titanium reinforced hardened square link chain mated to an integrated X2P Dual Lock Down head featuring new double rubber cover for better protection against bumps and hits.

Chain Dimensions: 70cm x 10mm (2.3' x 0.39")



Mastiff | 8118

4.92' 10mm (0.39") titanium reinforced hardened square link chain mated to an integrated X2P Dual Lock Down head featuring new double rubber cover for better protection against bumps and hits.

Chain Dimensions: 150cm x 10mm (4.92' x 0.39")



Mastiff | 8119

2.59' 8mm (0.32") titanium reinforced hardened square link chain mated to an integrated X2P Dual Lock Down head featuring new double rubber cover for better protection against bumps and hits.

Chain Dimensions: 80cm x 8mm (2.59' x 0.32")



Mastiff | 8123

User settable Steel Ball Combo lock is permanently forged to compact 2.5' 6mm (0.24") titanium reinforced hardened steel square link chain.

Chain Dimensions: 120cm x 6mm (4' x 0.24")



Mastiff | 8122

User settable Steel Ball Combo lock is permanently forged to compact 2.5' 6mm (0.24") titanium reinforced hardened steel square link chain.

Chain Dimensions: 75cm x 6mm (2.46' x 0.24")



Mastiff | 8022D

Compact 2.5' 8mm (0.32") titanium reinforced hardened steel square link chain. Mastiff rotary lock with Deadbolt mechanism for added security.

Chain Dimensions: 80cm x 8mm (2.59' x 0.32")

Note: No light key

ADDITIONAL FEATURES



5 laser cut keys (1 micro-light and 4 extra grip keys) Micro-light key projects a bright white beam



Mastiff | 8120

4' 8mm (0.32") titanium reinforced hardened square link chain mated to an integrated X2P Dual Lock Down head featuring new double rubber cover for better protection against bumps and hits.

Chain Dimensions: 120cm x 8mm (4' x 0.32")



Mastiff | 8121

4.92' 8mm (0.32") titanium reinforced hardened square link chain mated to an integrated X2P Dual Lock Down head featuring new double rubber cover for better protection against bumps and hits.

Chain Dimensions: 150cm x 8mm (4.92' x 0.32")



Mastiff | 8124

User settable Steel Ball Combo lock is permanently forged to compact 2.5' 4mm (0.16") titanium reinforced hardened steel square link chain.

Chain Dimensions: 75cm x 4mm (2.46' x 0.16")



Mastiff | 8125

User settable Steel Ball Combo lock is permanently forged to compact 2.5' 4mm (0.16") titanium reinforced hardened steel square link chain.

Chain Dimensions: 120cm x 4mm (4' x 0.16")

ADDITIONAL FEATURES



5 heavy-duty F-style keys Note: No light key



Armored cable locks offer the lighter weight of a high strength steel cable with the added protection of a hardened steel sheath that shrugs off attack from bolt and wire cutters. High strength twisted steel cable is permanently forged to a X2P Double Bolt lock head featuring new double rubber coated lock head covers for a comfortable grip and added protection against knocks and hits.

OnGuard Armored locks feature:

- High strength twisted steel cable encased in a cut-resistant hardened steel sheath that resists cutting.
- X2P Double Bolt lock mechanism provides ultimate pull resistance.
- Vinyl coated armor protect delicate paint jobs and finishes.
- NEW double rubber coated lock head covers provide better grip and protect against drops and hits.



Pat. Pend.

Z-Cylinder

The Z-Cylinder offers high pick protection and feature BumpBlock™ technology rendering bump keys useless. Lock mechanism is encased in ultra-hardened steel to resist drilling or pulling.



BUMPBLOK
Cylinder design prevents lock bumping



Patented
US 7,823,424 B2

X2P Double Bolt

Cable locks with X2P Dual Lock Down mechanisms secure cable to lock head in two places for high pull and pry resistance.



Steel Ball Combo

Steel Ball Combo locks use a smooth running, steel ball click gear system that resists picking and pulling.



Pat. Pend.

ADDITIONAL FEATURES



5 laser cut keys
(1 micro-light and 4 extra grip keys)

Micro-light key projects a bright white beam



Rottweiler 8023 | Page 30
110cm x 30mm [3.57' x 1.18"]



Rottweiler 8023L | Page 30
220cm x 30mm [7.13' x 1.18"]

ROTTWEILER SERIES

- X2 Double Bolt Locking Mechanism
- 30mm [1.18"] Twisted steel cable protected by hardened steel links



Rottweiler 8024 | 8024X Page 31
120cm x 25mm [4' x 1"]



Rottweiler 8025 | 8025X Page 31
180cm x 25mm [6' x 1"]

ROTTWEILER SERIES

- X2 Double Bolt Locking Mechanism
- 25mm [1"] Twisted steel cable protected by hardened steel links



Rottweiler 8026 | 8026X Page 31
100cm x 20mm [3.24' x 0.79"]

ROTTWEILER SERIES

- X2 Double Bolt Locking Mechanism
- 20mm [0.79"] Twisted steel cable protected by hardened steel links



Rottweiler 8126 | Page 31
80cm x 15mm [2.62' x 0.59"]



Rottweiler 8127 | Page 31
80cm x 20mm [2.62' x 0.79"]

ROTTWEILER SERIES

- Combo locks feature steel ball Click-Combo Gear System that's user settable with 10,000 possible variations.
- 15-20mm [0.59-0.79"] Twisted steel cable protected by hardened steel links

ROTTWEILER SERIES

Armored cable locks offer the lighter weight of a high strength steel cable with the added protection of a hardened steel sheath that shrugs off attack from bolt and wire cutters. High strength twisted steel cable is permanently forged to a X2P Double Bolt lock head featuring new double rubber coated lock head covers for a comfortable grip and added protection against knocks and hits.

- High strength twisted steel cable encased in a cut-resistant hardened steel sheath that resists cutting.
- X2P Double Bolt lock mechanism provides ultimate pull resistance.
- Vinyl coated armor protect delicate paint jobs and finishes.
- NEW double rubber coated lock head covers provide better grip and protect against drops and hits.

Locking Mechanism: X2P Double Bolt
Tumbler Mechanism: Z-Cylinder, European Type
Cable Diameter: 20-30mm (0.79-1.19")
 Twisted steel cable protected by hardened steel armor to resist attack from bolt and wire cutters.
Keys: 5 laser-cut keys, 1 with LED micro-light
Warranty: Lifetime



Rottweiler | 8023

X2P Double Bolt Lock for ultimate pull resistance is permanently forged to a 110cm x 30mm (3.57' x 1.18") twisted steel cable protected by hardened steel armor to resist attack from bolt and wire cutters.

Cable Dimensions: 110cm x 30mm (3.57' x 1.19")

ADDITIONAL FEATURES



5 laser cut keys (1 micro-light and 4 extra grip keys)
 Micro-light key projects a bright white beam



Locks shown on this page feature X2P Double Bolt Locking mechanisms



Rottweiler | 8024 | 8024X

Lighter, more flexible 120cm x 25mm (4' x 1") armored cable with X2P Double Bolt lock head.

Cable Dimensions: 120cm x 25mm (4' x 1")



Rottweiler | 8025 | 8025X

Same features as 8024 with longer 180cm x 25mm (6' x 1") armored steel cable for more locking options.

Cable Dimensions: 180cm x 25mm (6' x 1")



Rottweiler | 8026 | 8026X

Lighter weight 100cm x 20mm (3.24' x 0.79") armored steel cable with X2P Double Bolt lock head.

Cable Dimensions: 100cm x 20mm (3.24' x 0.79")



Locks shown on this page feature X2P Double Bolt Locking mechanisms

ADDITIONAL FEATURES

5 laser cut keys (1 micro-light and 4 extra grip keys)
 Micro-light key projects a bright white beam



Rottweiler | 8126

Improved user-settable steel ball click-combo lock system forged to a 80cm x 15mm (2.62' x 0.59") twisted steel cable protected by hardened steel armor.

Cable Dimensions: 80cm x 15mm (2.62' x 0.59")



Rottweiler | 8127

Improved user-settable steel ball click-combo lock system forged to a 80cm x 20mm (2.62' x 0.79") twisted steel cable protected by hardened steel armor.

Cable Dimensions: 80cm x 20mm (2.62' x 0.79")



Locks shown on this page feature Steel Ball Click-Combo-Gear System

LOCKING TECHNOLOGY

Light weight, easy to carry and available with either keyed or combination lock mechanisms, coil cable locks offer bike riders fast, convenient security for medium to low risk situations. Heavy-duty steel cables are permanently forged to lock heads for added security, cables are vinyl coated to protect paint and finishes.

OnGuard Coil Cable locks feature:

- Heavy-duty steel cables are self-coiling for convenience.
- Vinyl coated cables protect paint and finishes.
- Lock heads are permanently forged to cable ends.
- Key locks feature X2P Double Bolt lock heads for ultimate pull resistance.
- Combo locks feature steel ball Click-Combo-Gear System that's user settable with 10,000 possible variations.
- Attached Velcro straps contain unruly coils during transport.
- Most models include NEW All-Tube Twist Lock mounting bracket.
- New Double Rubber Coated lock head covers protect paint and finishes



Pat. Pend.

Z-Cylinder

The Z-Cylinder offers high pick protection and feature BumpBlock™ technology rendering bump keys useless. Lock mechanism is encased in ultra-hardened steel to resist drilling or pulling.

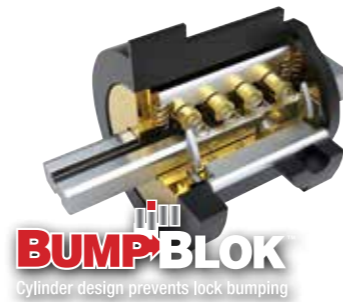

BUMPBLOK
Cylinder design prevents lock bumping



Patented
US 7,823,424 B2

X2 Double Bolt

Cable locks with X2P Dual Lock Down mechanisms secure cable to lock head in two places for high pull and pry resistance.



Steel Ball Combo

Steel Ball Combo locks use a smooth running, steel ball click gear system that resists picking and pulling.



Pat. Pend.

ADDITIONAL FEATURES



Twist Lock Quick Release multi-position mounting bracket

5 laser cut keys
(1 micro-light and 4 extra grip keys)

Micro-light key projects a bright white beam



Doberman 8027 | Page 34
185cm x 15mm [6' x 0.59"]



Doberman 8028 | 8028X Page 35
185cm x 12mm [6' x 0.47"]



Doberman 8029 | 8029X Page 35
185cm x 10mm [6' x 0.39"]

DOBERMAN SERIES

- X2 Double Bolt Locking Mechanism
- 10-15mm [0.39-0.59"] heavy duty self coiling cable



Doberman 8030 | Page 36
185cm x 15mm [6' x 0.59"]



Doberman 8031 | 8031X Page 37
185cm x 12mm [6' x 0.47"]



Doberman 8031L | Page 37
240m x 12mm [7.78' x 0.47"]



Doberman 8032 | Page 37
185cm x 10mm [6' x 0.32"]

DOBERMAN SERIES

- Steel ball Click-Combo Gear System has user settable combination
- 10-15mm [0.39-0.59"] heavy duty self coiling cable



Doberman 8031GLO | Page 38
185cm x 12mm [6' x 0.47"]

DOBERMAN SERIES

- Steel ball Click-Combo Gear System has user settable combination
- 12mm [0.47"] heavy duty self coiling cable



Doberman Key 8033 | Page 39
185cm x 8mm [6' x 0.32"]



Doberman Combo 8034 | Page 39
185cm x 8mm [6' x 0.32"]

DOBERMAN SERIES

- Laminated steel padlock with plated body and rubber cover / stainless steel combination padlock 48mm steel body
- 8mm [0.32"] heavy duty self coiling cable



Key Alike Set 8150 | Page 39
3 x 8028



Key Alike Set 8151 | Page 39
8003 + 8028

KEY ALIKE SETS

DOBERMAN SERIES

Light weight, easy to carry and available with either keyed or combination lock mechanisms, coil cable locks offer bike riders fast, convenient security for medium to low risk situations. Heavy-duty steel cables are permanently forged to lock heads for added security, cables are vinyl coated to protect paint and finishes.

- Heavy-duty steel cables are self-coiling for convenience.
- Vinyl coated cables protect paint and finishes.
- Lock heads are permanently forged to cable ends.
- Key locks feature X2P Double Bolt lock heads for ultimate pull resistance.
- Attached Velcro straps contain unruly coils during transport.
- Most models include NEW All-Tube Twist Lock mounting bracket.
- New Double Rubber Coated lock head covers protect paint and finishes

Locking Mechanism: X2P Double Bolt Z-Cylinder, European Type
Tumbler Mechanism:
Cable Diameter: 10-15mm (0.39-0.59") heavy duty self coiling cable
Keys: 5 laser-cut keys
Warranty: Lifetime



15MM [0.59"]



Locks shown on this page feature X2P Double Bolt Locking mechanisms



Doberman | 8027

The ultimate pull resistance of an X2P Power Double Bolt permanently forged to a 185cm x 15mm (6' x 0.59") heavy-duty self-coiling cable. Thick vinyl coating on cable protects paint and finishes. Attached hook-and-loop strap helps wrangle unruly cable coils. Bracket included.

Cable Dimensions: 185cm x 15mm (6' x 0.59")



12MM [0.47"]



Doberman | 8028 | 8028X

X2P Power Double Bolt lock permanently forged to medium duty 185cm x 12mm (6' x 0.47") self-coiling cable. Bracket included.

Cable Dimensions: 185cm x 12mm (6' x 0.47")



12MM [0.47"]



Locks shown on this page feature X2P Double Bolt Locking mechanisms



Doberman | 8029 | 8029X

The extra protection of a X2P Power Double Bolt lock permanently forged to a lighter duty 185cm x 10mm (6' x 0.39") self-coiling cable. Bracket included.

Cable Dimensions: 185cm x 10mm (6' x 0.39")



10MM [0.39"]



10MM [0.39"]

ADDITIONAL FEATURES



Twist Lock Quick Release multi-position mounting bracket



5 laser cut keys (1 micro-light and 4 extra grip keys) Micro-light key projects a bright white beam

ADDITIONAL FEATURES

Twist Lock Quick Release multi-position mounting bracket



5 laser cut keys
Note: no light key



DOBERMAN SERIES

Light weight, easy to carry and available with either keyed or combination lock mechanisms, coil cable locks offer bike riders fast, convenient security for medium to low risk situations. Heavy-duty steel cables are permanently forged to lock heads for added security, cables are vinyl coated to protect paint and finishes.

- Heavy-duty steel cables are self-coiling for convenience.
- Vinyl coated cables protect paint and finishes.
- Lock heads are permanently forged to cable ends.
- Combo locks feature steel ball Click-Combo-Gear System that's user settable with 10,000 possible variations.
- Attached Velcro straps contain unruly coils during transport.
- Most models include NEW All-Tube Twist Lock mounting bracket.
- New Double Rubber Coated lock head covers protect paint and finishes

Locking Mechanism: Steel ball Click-Combo-Gear System
Cable Diameter: 10-15mm (0.39-0.59") heavy duty self coiling cable
Warranty: Lifetime

SBC Locks shown on this page feature Steel Ball Click-Combo-Gear System



15MM [0.59"]

HIGH SECURITY SECURITY 10 20 30 40 **45** RATING 50 60 70 80 90 100

Doberman | 8030
 User settable Steel Ball Combo lock is permanently forged to heavy-duty 185cm x 15mm (6' x 0.59") self-coiling cable. Bracket included.

Cable Dimensions: 185cm x 15mm (6' x 0.59")



12MM [0.47"]

HIGH SECURITY SECURITY 10 20 30 40 **40** RATING 50 60 70 80 90 100

Doberman | 8031X | 8031X
 User settable Steel Ball Combo lock is permanently forged to medium-duty 185cm x 12mm (6' x 0.47") self-coiling cable. Bracket included.

Cable Dimensions: 185cm x 12mm (6' x 0.47")



12MM [0.47"]



12MM [0.47"]

HIGH SECURITY SECURITY 10 20 30 40 **40** RATING 50 60 70 80 90 100

Doberman | 8031L
 User settable Steel Ball Combo lock is permanently forged to medium-duty 240cm x 12mm (7.78' x 0.47") self-coiling cable. Bracket included.

Cable Dimensions: 240cm x 12mm (7.78' x 0.47")

SBC Locks shown on this page feature Steel Ball Click-Combo-Gear System

ADDITIONAL FEATURES



Twist Lock Quick Release multi-position mounting bracket

ADDITIONAL FEATURES



Twist Lock Quick Release multi-position mounting bracket

10MM [0.39"]

BASIC SECURITY SECURITY 10 20 30 40 **35** SECURITY RATING 50 60 70 80 90 100

Doberman | 8032
 Steel Ball Combo lock body is permanently forged to light duty 185cm x 10mm (6' x 0.39") self-coiling cable. Bracket included.

Cable Dimensions: 185cm x 10mm (6' x 0.39")

DOBERMAN SERIES

Light weight, easy to carry and available with either keyed or combination lock mechanisms, coil cable locks offer bike riders fast, convenient security for medium to low risk situations. Heavy-duty steel cables are permanently forged to lock heads for added security, cables are vinyl coated to protect paint and finishes.

- Heavy-duty steel cables are self-coiling for convenience.
- Vinyl coated cables protect paint and finishes.
- Lock heads are permanently forged to cable ends.
- Combo locks feature steel ball Click-Combo-Gear System that's user settable with 10,000 possible variations.
- Attached Velcro straps contain unruly coils during transport.
- Most models include NEW All-Tube Twist Lock mounting bracket.
- New Double Rubber Coated lock head covers protect paint and finishes

Locking Mechanism: Steel ball Click-Combo-Gear System
Cable Diameter: 12mm (0.47) heavy duty self coiling cable
Warranty: Lifetime



SBC Locks shown on this page feature Steel Ball Click-Combo-Gear System

ADDITIONAL FEATURES



Twist Lock Quick Release multi-position mounting bracket



Doberman Glo | 8031GLO

Internal LED micro light backlights the clear tumblers from within making reading the numbers after dark a breeze. Steel Ball Combo lock is permanently forged to medium duty 185cm x 12mm (6' x 0.47") self-coiling cable. Bracket included.

Cable Dimensions: 185cm x 12mm (6' x 0.47")



Doberman Key | 8033

Laminated steel padlock with smooth brass lock mechanism and 8mm (0.32") hardened steel shackle paired with a light duty 185cm x 8mm (6' x 0.32") vinyl coated twisted steel cable.

Cable Dimensions: 185cm x 8mm (6' x 0.32")

Notes: No mounting bracket included, No light key



Doberman Combo | 8034

Stainless steel combination padlock with 8mm (0.32") hardened steel shackle paired with a light duty 185mm x 8mm (6' x 0.32") vinyl coated twisted steel cable.

Cable Dimensions: 185cm x 8mm (6' x 0.32")

Note: No mounting bracket included



Key Alike Set | 8150

3 x Doberman 8028 Key Alike

Cable Dimensions: 185cm x 12mm (6' x 0.47")



Key Alike Set | 8151

Shackle Dimensions: 115mm x 230mm (4.53" x 9.06") x 14mm (0.55") D

Cable Dimensions: 185cm x 12mm (6' x 0.47")

Lighter and easier to handle than chain locks, cable locks provide the extra protection of a heavy-duty twisted steel cable combined with X2P Double Bolt and Steel-Ball-Combo locks making them a great choice for cyclists and power sport users.

OnGuard Cable locks feature:

- Extra flexible steel cables for ease of use.
- Vinyl coatings protect paint and finishes.
- Lock heads are permanently forged to cable ends.
- X2P Double Bolt key lock for ultimate pull resistance.
- Steel Ball Combo lock is user-settable with 10,000 possible variations.
- Attached Velcro straps help contain cable during transport.
- New double rubber coated lock head cover protects paint and finishes
- Automatic or manual dust covers protect lock internals against the elements



Pat. Pend.

Z-Cylinder

The Z-Cylinder offers high pick protection and feature BumpBlock™ technology rendering bump keys useless. Lock mechanism is encased in ultra-hardened steel to resist drilling or pulling.



BUMPBLOK
Cylinder design prevents lock bumping



Patented
US 7,823,424 B2

X2P Double Bolt

Cable locks with X2P Dual Lock Down mechanisms secure cable to lock head in two places for high pull and pry resistance.



Steel Ball Combo

Steel Ball Combo locks use a smooth running, steel ball click gear system that resists picking and pulling.



Pat. Pend.

ADDITIONAL FEATURES



5 laser cut keys
(1 micro-light and 4 extra grip keys)

Micro-light key projects a bright white beam



Akita 8036 | Page 42
185cm x 20mm [6' x 0.79"]



Akita 8037 | Page 42
100cm x 20mm [3.24' x 0.79"]



Akita 8038 | Page 42
100cm x 15mm [3.24' x 0.59"]

AKITA SERIES

- X2 Double Bolt Locking Mechanism
- 15-20mm [0.59-0.79"] heavy duty extra flexible steel cable
- Non Coiled



Akita 8039 | 8039X Page 43
120cm x 12mm [4' x 0.47"]



Akita 8040 | 8040X Page 43
185cm x 12mm [6' x 0.47"]



Akita 8040L | Page 43
300cm x 12mm [9.73' x 0.47"]

AKITA SERIES

- X2 Double Bolt Locking Mechanism
- 12mm [0.47"] heavy duty extra flexible steel cable
- Non Coiled



Akita 8041 | Page 44
185cm x 12mm [6' x 0.47"]



Akita 8042 | 8042X Page 44
185cm x 10mm [6' x 0.39"]

AKITA SERIES

- Steel ball Click-Combo Gear System has user settable combination
- 10-12mm [0.39-0.47"] heavy duty extra flexible steel cable



Akita 8043 | Page 45
220cm x 10mm [7.13' x 0.39"]



Akita 8044 | Page 45
120cm x 10mm [4' x 0.39"]



Akita 8073 | Page 45
9.3m x 10mm [30.16' x 0.39"]



Akita 8080 | Page 45
4.6m x 10mm [15' x 0.39"]

AKITA SERIES

- Cinch-loop – Requires less cable for effective lock-ups
- 10mm [0.39"] heavy duty extra flexible steel cable



Akita 8045 | Page 45
53cm x 5mm [1.72' x 0.20"]

AKITA SERIES

- Cable permanently secured, prevents theft of quick release seats
- 5mm [0.20"] heavy duty extra flexible steel cable



Terrier Combo 4 8061 | Page 46
120cm x 6mm [4' x 0.24"]



Terrier Combo 7 8062 | Page 46
210cm x 6mm [7' x 0.24"]



Terrier Combo GLO 8064 | Page 46
180cm x 10mm [6' x 0.39"]



Terrier Roller 8063 | Page 46
90cm x 2 mm [2.92' x 0.08"]



Terrier Roller Mini 8063M | Page 46
60cm x 1.6mm [1.95' x 0.06"]

TERRIER SERIES

- Set your own digit combination
- Pocket size for easy carrying
- Extra flexible steel cable

AKITA SERIES

Lighter and easier to handle than chain locks, cable locks provide the extra protection of a heavy-duty twisted steel cable combined with X2P Double Bolt locks making them a great choice for cyclists and power sport users.

- Extra flexible steel cables for ease of use.
- Vinyl coatings protect paint and finishes.
- Lock heads are permanently forged to cable ends.
- X2P Double Bolt key lock for ultimate pull resistance.
- NEW Z-Cylinder is bump-proof and resists picking, pulling or drilling
- Attached Velcro straps help contain cable during transport.
- New double rubber coated lock head cover protects paint and finishes.
- Automatic or manual dust covers protect lock internals against the elements.

Locking Mechanism: X2P Double Bolt
Tumbler Mechanism: Z-Cylinder, European Type
Cable Diameter: 12-20mm (0.47-0.79") heavy duty extra flexible steel cable
Keys: 5 laser-cut keys, 1 with LED micro-light
Warranty: Lifetime



20MM [0.79"]



Locks shown on this page feature X2P Double Bolt Locking mechanisms



Akita | 8036

X2P Double Bolt Lock for ultimate pull resistance is permanently forged to a heavy-duty 185cm x 20mm (6' x 0.79") extra flexible steel cable. Rubber and vinyl coatings on lock body and cable protect paint and delicate finishes.

Cable Dimensions: 185cm x 20mm (6' x 0.79")

ADDITIONAL FEATURES



5 laser cut keys (1 micro-light and 4 extra grip keys)
 Micro-light key projects a bright white beam



12MM [0.47"]



12MM [0.47"]



12MM [0.47"]



Akita | 8039 | 8039X

X2P Double Bolt Lock for ultimate pull resistance forged to a 120cm x 12mm (4' x 0.47") medium-duty, extra-flexible steel cable.

Cable Dimensions: 120cm x 12mm (4' x 0.47")



12MM [0.47"]



Akita | 8040 | 8040X

X2P Double Bolt Lock for ultimate pull resistance forged to a 185cm x 12mm (6' x 0.47") medium-duty, extra-flexible steel cable.

Cable Dimensions: 185cm x 12mm (6' x 0.47")



12MM [0.47"]



Akita | 8040L

X2P Double Bolt Lock forged to an extra long 300cm x 12mm (9.73' x 0.47") medium-duty, extra-flexible steel cable; ideal for securing bikes to car racks, snowmobiles and ATV to trailers or anywhere extra cable length is needed.

Cable Dimensions: 300cm x 12mm (9.73' x 0.47")

ADDITIONAL FEATURES



5 laser cut keys
 Note: No light key



Locks shown on this page feature X2P Double Bolt Locking mechanisms



20MM [0.79"]



15MM [0.59"]



Akita | 8037

X2P Double Bolt Lock for ultimate pull resistance forged to a shorter 100cm x 20mm (3.24' x 0.79") vinyl coated extra flexible steel cable.

Cable Dimensions: 100cm x 20mm (3.24' x 0.79")



Akita | 8038

X2P Double Bolt Lock for ultimate pull resistance forged to a 100cm x 15mm (3.24' x 0.59") vinyl coated extra flexible steel cable.

Cable Dimensions: 100cm x 15mm (3.24' x 0.59")

AKITA SERIES

Lighter and easier to handle than chain locks, cable locks provide the extra protection of a heavy-duty twisted steel cable combined with Steel-Ball-Combo lock making them a great choice for cyclists and power sport users.

- Extra flexible steel cables for ease of use.
- Vinyl coatings protect paint and finishes.
- Combo locks feature steel ball Click-Combo-Gear System that's user settable with 10,000 possible variations.
- Ergonomic dials for precise usage.
- Attached Velcro straps help contain cable during transport.
- New double rubber coated lock head cover protects paint and finishes.



Locks shown on this page feature Steel Ball Click-Combo-Gear System

12MM [0.47"]



Akita | 8041
Convenient user-settable Steel Ball Combo lock forged to medium duty 185cm x 12mm (6' x 0.47") extra-flexible, vinyl coated steel cable.

Cable Dimensions: 185cm x 12mm (6' x 0.47")



Akita | 8042 | 8042X
Convenient user-settable Steel Ball Combo lock forged to light duty 185cm x 10mm (6' x 0.39") extra-flexible, vinyl coated steel cable.

Cable Dimensions: 185cm x 10mm (6' x 0.39")



10MM [0.39"]



Akita | 8073
Super long 9.3m x 10mm (30' x 0.39") medium duty vinyl coated extra-flexible steel cable with permanently swedged, loops is great for securing snowmobiles and ATV to trailer or multiple bicycles, motorcycles or scooters.

Cable Dimensions: 9m x 10mm (30.16' x 0.39")



10MM [0.39"]



Akita | 8043
Long 220cm x 10mm (7.13' x 0.39") medium duty vinyl coated extra-flexible steel cable with permanently swedged loops. Includes Velcro strap.

Cable Dimensions: 220cm x 10mm (7.13' x 0.39")



10MM [0.39"]



Akita | 8044
Medium 120cm x 10mm (4' x 0.39") medium duty vinyl coated extra-flexible steel cable with permanently swedged loops. Includes Velcro strap.

Cable Dimensions: 120cm x 10mm (4' x 0.39")

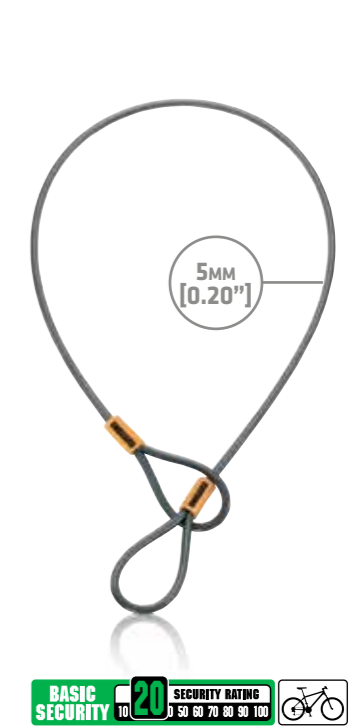

5MM [0.20"]



Akita | 8045
Short 53cm x 5mm (1.72' x 0.20") light duty vinyl coated extra-flexible steel cable with permanently swedged loops. Includes Velcro strap.

Cable Dimensions: 53cm x 5mm (1.72' x 0.20")



10MM [0.39"]



Akita | 8080
Extra long 4.6m x 10mm (15' x 0.39") medium duty vinyl coated extra-flexible steel cable with permanently swedged, loops.

Cable Dimensions: 4.6m x 10mm (15' x 0.39")

TERRIER SERIES

Small combo cable locks are perfect for securing skis, snowboards, helmets, leathers or other personal items that don't require maximum security.

- User settable combinations
- Large numbers are easy to see
- Glove friendly raised dials
- Vinyl coated cables protect paint and finishes



BASIC SECURITY TO 20 SECURITY RATING

Terrier Roller | 8063

Pocket-sized combo lock with 90 cm x 2mm (2.92' x 0.08") retractable cable is super convenient for securing bicycles, helmets or anytime light security is needed. User settable 3 digit combination.

Cable Dimensions: 90cm x 2mm (2.92' x 0.08")



BASIC SECURITY TO 20 SECURITY RATING

Terrier Roller | 8063M

Ultra-compact combo lock with shorter 60 cm x 1.6mm (1.95' x 0.06") retractable cable for securing bicycles, helmets or anytime light security is needed. User settable 3 digit combination.

Cable Dimensions: 60cm x 1.6mm (1.95' x 0.06")



BASIC SECURITY TO 25 SECURITY RATING

Terrier Combo 4 | 8061

Small combo lock with 120cm x 6mm (4' x 0.24") twisted steel cable provides light security for bicycles, skis, snowboards, helmets, etc.

Cable Dimensions: 120cm x 6mm (4' x 0.24")

BASIC SECURITY TO 25 SECURITY RATING

Terrier Combo 7 | 8062

Small combo lock with same features as 8061 but with a longer 210cm x 6mm (7' x 0.24") cable for more locking options.

Cable Dimensions: 210cm x 6mm (7' x 0.24")



BASIC SECURITY TO 35 SECURITY RATING

Terrier Combo Glo | 8064

Internal LED microlight illuminates the clear tumblers making reading the numbers after dark a breeze. Small combo lock with 180cm x 10mm (6' x 0.39") twisted steel cable provides light security for bicycles, skis, snowboards, helmets, etc.

Cable Dimensions: 180cm x 10mm (6' x 0.39")



ULTIMATE SECURITY SECURITY RATING TO 80

Beast | 8101

Beast padlock featuring X2P Dual Lock Down mechanism that secures shackle on both sides with a super-short 11mm (0.43") shackle that provides no leverage points for prying or jacking. Rubber coated lock body protects paint and finishes.

- X2P Dual Lock Down mechanism secures shackle on both sides
- Z-Cylinder resists all attacks from picking, pulling or drilling
- Double Rubber coated body protect finishes and paint

Shackle Diameter: 11mm (0.43") Hardened Steel



HIGH SECURITY SECURITY RATING TO 50

BullMastiff | 8102

Laminated steel padlock with smooth brass lock mechanism and 10mm (0.39") hardened steel shackle.

- Laminated steel padlock with brass internals with 10mm (0.39") hardened steel shackle
- Non-marring padlock bumper protects paint and finishes
- 5 heavy-duty F-style keys

Shackle Diameter: 10mm (0.39") Hardened Steel

ADDITIONAL FEATURES

5 heavy-duty F-style keys



HIGH SECURITY SECURITY RATING TO 40

BullMastiff | 8103

The 8103 Bull Mastiff features smooth, one-handed rotary operation and tight shackle-to-body clearance to eliminate pry points to make cutting difficult.

- Rotary style lock provides smooth, one-handed operation
- Tight shackle-to-body clearance eliminates pry points and makes cutting difficult
- 5 heavy-duty F-style keys

Shackle Diameter: 10mm (0.39") Hardened Steel

ADDITIONAL FEATURES

5 heavy-duty F-style keys



BEAST & BULLMASTIFF SERIES

ADDITIONAL FEATURES



5 laser cut keys (1 micro-light and 4 extra grip keys) Micro-light key projects a bright white beam



HIGH SECURITY SECURITY RATING TO 40

BullMastiff | 8104

Stainless steel combination padlock with 8mm (0.32") hardened steel shackle.

- Stainless steel combo lock with 8mm (0.32") hardened steel shackle

Shackle Diameter: 8mm (0.32") Hardened Steel

Disc locks provide motorcyclists and other power sports users outstanding security in a small convenient size. Shackle models work as a stand-alone rotor lock or with a chain for more locking options. Stapler and pin type models offer great protection against drive off thefts and easily fit in a pocket or tank bag. Most disc locks come with carrying case and disc reminder cable to prevent accidental drive aways.

OnGuard Disc locks feature:

- X4P lock mechanism on Boxers secure both sides of the shackle.
- Hardened steel shackles and pins resist prying, cutting or jacking
- Rubber coatings protect paint and finishes
- Most models include carrying case and disc reminder cable



Z-Cylinder

The Z-Cylinder offers high pick protection and feature BumpBlock™ technology rendering bump keys useless. Lock mechanism is encased in ultra-hardened steel to resist drilling or pulling.



X4P Quattro Bolt

X4P Quattro Bolt mechanism secures the shackle to the crossbar in four places maximizing strength to resist pulling, jacking, prying and twisting.



ADDITIONAL FEATURES



5 laser cut keys
(1 micro-light and 4 extra grip keys)
Micro-light key projects a bright white beam



Carrying pouch with belt clip
The disc reminder prevents riding away while disc lock is still engaged



Boxer 8046 | Page 50
55 x 55mm [2.17 x 2.17"]



Boxer 8048 | Page 50
55 x 55mm [2.17 x 2.17"]



Boxer 8048C | Page 50
55 x 55mm [2.17 x 2.17"]

BOXER SERIES

- X4 Quattro Bolt Locking Mechanism
- 14-16.8mm [0.55-0.66"] ultra hardened steel shackle



Boxer 8051 | Page 51
5.5mm [0.22"]



Boxer 8052 | Page 51
10mm [0.39"]



Boxer 8054 | Page 51
8mm [0.32"]

BOXER SERIES

- Touch lock system
- 5.5-10mm [0.22-0.39"] ultra hardened steel pin
- Stapler type disc lock



Double Team 8110 | Page 51
Disc lock + cable: 8052 + 8062

Disc Reminder 8056 | Page 51

BOXER SERIES

- Touch lock system
- 10mm [0.39"] ultra hardened steel pin

STAINLESS-STEEL MONOBLOC BODY



Smart Alarm Disc Lock 8246
Page 52 | 10mm [0.39"]

Smart Alarm Disc Lock 8251
Page 52 | 14mm [0.55"]



Smart Alarm Disc Lock 8248
Page 52 | 10mm [0.39"]

Smart Alarm Disc Lock 8253
Page 52 | 14mm [0.55"]

DIECAST METAL BODY



Smart Alarm Disc Lock 8256
Page 52 | 6mm [0.24"]

Smart Alarm Disc Lock 8261
Page 52 | 10mm [0.39"]



Smart Alarm Disc Lock 8258
Page 52 | 6mm [0.24"]

Smart Alarm Disc Lock 8263
Page 52 | 10mm [0.39"]

SMART ALARM DISC LOCKS

- Double Locking System
- 10-14mm [0.39-0.55"] Carbide Reinforced Locking Pin
- 120dB Alarm

BOXER SERIES

Small enough to fit in a jacket pocket or tank bag, disc locks are great for motorcyclists and other power sport users. Boxer Series shackle locks can be used as stand-alone rotor locks or combined with a chain or cable for more locking options. Stapler and pin type models offer great protection against drive off theft. Most locks come with carrying case and bright orange reminder cable to prevent accidental drive aways.

- X4P lock mechanism on Boxers secure both sides of the shackle.
- Hardened steel shackles and pins resist prying, cutting or jacking
- Rubber coatings protect paint and finishes
- Most models include carrying case and disc reminder cable

X4P Locks shown on this page feature X4P Quattro bolt locking mechanisms

BOXER SERIES | 8046, 8048, 8048C
ANTI-THEFT PROTECTION OFFER for power sport
\$751



ULTIMATE SECURITY SECURITY RATING **95** 10 20 30 40 50 60 70 80 90 100

ULTIMATE SECURITY SECURITY RATING **85** 10 20 30 40 50 60 70 80 90 100

Boxer | 8046

Large 55mm x 55mm (2.17" x 2.17") opening fits large disc and rotor openings. Massive 16.8mm (0.66") hardened steel shackle resists all attack from cutting, prying or jacking. X4P Quattro Bolt locking system secures the shackle on four sides for ultimate protection. Included disc reminder helps prevent accidental drive offs.

Shackle Diameter: 16.8mm (0.66")
Hardened Steel

Boxer | 8048

Large 55mm x 55mm (2.17" x 2.17") opening fits many disc and rotor openings. 14mm (0.55") hardened steel shackle resists all attack from cutting, prying or jacking. X4P Quattro Bolt locking system secures the shackle on four sides for ultimate protection. Included disc reminder helps prevent accidental drive offs.

Shackle Diameter: 14mm (0.55")
Hardened Steel



ULTIMATE SECURITY SECURITY RATING **85** 10 20 30 40 50 60 70 80 90 100

Boxer | 8048C

Same as 8048C with yellow colored shackle to further remind rider that disc is locked.

Shackle Diameter: 14mm (0.55")
Hardened Steel



Disc Reminder | 8056

The disc reminder prevents riding away while disc lock is still engaged

HIGH SECURITY SECURITY RATING **50** 10 20 30 40 50 60 70 80 90 100

Boxer | 8051

Stapler-style disc lock featuring Touch Lock System for convenient one-hand operation. Pick, pull and drill resistant Z-Cylinder locking mechanism. 5.5mm (0.22") hardened steel pin secures lock to disc, includes disc reminder cable and carrying pouch.

Pin Dimensions: 5.5mm (0.22"),
Hardened Steel

HIGH SECURITY SECURITY RATING **60** 10 20 30 40 50 60 70 80 90 100

Boxer | 8052

Stapler-style disc lock featuring Touch Lock System secured by a pick, pull and drill resistant Z-Cylinder locking mechanism. Larger 10mm (0.39") hardened steel pin secures lock to disc, includes disc reminder cable and carrying pouch.

Pin Dimensions: 10mm (0.39"),
Hardened Steel

HIGH SECURITY SECURITY RATING **55** 10 20 30 40 50 60 70 80 90 100

Boxer | 8054

Stapler-style disc lock featuring a Touch Lock System secured by a pick, pull and drill resistant M-Cylinder locking mechanism. Intermediate 8mm (0.32") hardened steel pin secures lock to disc, includes disc reminder cable and carrying pouch.

Pin Dimensions: 8mm (0.32"),
Hardened Steel

HIGH SECURITY SECURITY RATING **60** 10 20 30 40 50 60 70 80 90 100

Double Team | 8110

Double Team it with a 8052 stapler-style disc lock combined with a Terrier Glo Combo 7 8062 vinyl coated cable lock for securing helmets, leathers or other small items.



Boxer Stapler style Series:

- Z-Cylinder resists all attacks from picking, pulling or drilling
- Touch lock system for one-hand operation
- 5.5-10mm (0.22") hardened steel pin secures lock to disc
- Rounded design and centered keyway eliminates pry points
- Coated surfaces protect finishes and paint
- Disc reminder cable helps prevent accidental drive offs
- Included carrying pouch with belt clip



ADDITIONAL FEATURES



5 laser cut keys
(1 micro-light and 4 extra grip keys)
Micro-light key projects a bright white beam



Carrying pouch with belt clip



The disc reminder prevents riding away while disc lock is still engaged

ANTI-THEFT PROTECTION OFFER for power sport \$751

Smart Alarm Disc Locks provide motorcyclists and other power sports users outstanding security in a small convenient size. Stapler and pin type models offer great protection against drive off thefts and easily fit in a pocket or tank bag. Most disc locks come with carrying case and disc reminder cable to prevent accidental drive aways.

Alarm Disc Locks feature:

- Double Locking System
- Ice Spray-Proof Body & Key Barrel
- 10-14mm Carbide-Reinforced Locking Pin
- 120dB Alarm
- Auto Arm/Disarm
- Shock & Movement Sensors



ADDITIONAL FEATURES

5 laser cut keys
(1 micro-light and 4 extra grip keys)
Micro-light key projects a bright white beam

Carrying pouch with belt clip and disc reminder prevents riding away while disc lock is still engaged

120dB Alarm Disc Locks
Stainless-Steel Monobloc Body



Smart Alarm Disc Lock | 8246
Pin Dimensions: 10mm (0.39"),
Hardened Steel
Color: black



Smart Alarm Disc Lock | 8251
Pin Dimensions: 14mm (0.55"),
Hardened Steel
Color: black



Smart Alarm Disc Lock | 8248
Pin Dimensions: 10mm (0.39"),
Hardened Steel
Color: yellow



Smart Alarm Disc Lock | 8253
Pin Dimensions: 14mm (0.55"),
Hardened Steel
Color: yellow

120dB Alarm Disc Locks
Diecast Metal Body



Smart Alarm Disc Lock | 8256
Pin Dimensions: 6mm (0.24"),
Hardened Steel
Color: black



Smart Alarm Disc Lock | 8261
Pin Dimensions: 10mm (0.39"),
Hardened Steel
Color: black



Smart Alarm Disc Lock | 8258
Pin Dimensions: 6mm (0.24"),
Hardened Steel
Color: yellow



Smart Alarm Disc Lock | 8263
Pin Dimensions: 10mm (0.39"),
Hardened Steel
Color: yellow

120dB Alarm U-Locks

ANTI-THEFT PROTECTION OFFER for power sport \$751

Perfectly suited for cyclists and power sport users, Smart Alarm U-Locks offer our highest level of security in one convenient, easy-to-use design. OnGuard's wide range of shackle lengths, optional cables, pick, pull, bump and drill resistant cylinders.

Alarm U-Locks feature:

- High security locking mechanisms secure both sides of the shackle
- 14-16mm Hardened steel shackles are impervious to prying, jacking, or cutting
- Round profile and smooth edges eliminate leverage points
- Fully coated shackles and crossbar protects delicate finishes and paint jobs
- 120dB Alarm
- Auto Arm/Disarm
- Shock & Movement Sensors



ADDITIONAL FEATURES

Snap Lock Quick Release multi-position mounting bracket

5 laser cut keys



Smart Alarm U-Lock | 8266
Shackle Dimensions: 124mm x 208mm
(W x H x Diam)
4.88" x 8.19" x
16mm (0.63") D



Smart Alarm U-Lock | 8267
Shackle Dimensions: 85mm x 150mm
(W x H x Diam)
3.35" x 5.91" x
14mm (0.55") D



Smart Alarm U-Lock | 8268
Shackle Dimensions: 100mm x 258mm
(W x H x Diam)
3.94" x 10.16" x
14mm (0.55") D

This unique lock combines near U-lock security with the ease of use and versatility of a cable lock. Remarkably compact the K-9 is constructed of hardened steel plates and features OnGuard's pick, pull and drill proof Z-Cylinder. Once unfolded, the K-9 has the length to secure frames and wheels to a rack or other solid object. Included mounting bracket mounts to most bicycle tubes for easy transport.



Heavy Duty Link Plate Lock K9 | 8113

K9 Dimensions: 79cm (2.56')



Heavy Duty Link Plate Lock K9 | 8114

K9 Dimensions: 112.5cm (3.69')



Link Plate Lock K9 Key | 8116

K9 Dimensions: 75cm (2.46')

This unique lock combines near U-lock security with the ease of use and versatility of a cable lock. Remarkably compact the K-9 is constructed of hardened steel plates and features steel ball Click-Combo-Gear System that's user settable with 10,000 possible variations. Once unfolded, the K-9 has the length to secure frames and wheels to a rack or other solid object. Included mounting bracket mounts to most bicycle tubes for easy transport.



Link Plate Lock K9 Combo | 8115

K9 Dimensions: 88.5cm (2.9')



Link Plate Lock K9 Combo | 8116C

K9 Dimensions: 75cm (2.46')

ADDITIONAL FEATURES



5 laser cut keys
(1 micro-light and 4 extra grip keys)
Micro-light key projects a bright white beam



The DS system is an innovative leap in design, introducing significant features and benefits over existing locking systems and cylinders.

The world's first spring free patented locking system and cylinder. No more jammed locks

Neon U-Lock | 8152

Shackle Dimensions: 115mm x 292mm
(W x H x Diam)
11mm (0.43") D

Neon U-Lock | 8153

Shackle Dimensions: 115mm x 230mm
(W x H x Diam)
11mm (0.43") D

Neon U-Lock | 8155

Shackle Dimensions: 90mm x 140mm
(W x H x Diam)
11mm (0.43") D

Bracket and 2 keys included



Neon U-Lock + cable | 8154

Shackle Dimensions: 115mm x 230mm
(W x H x Diam)
11mm (0.43") D

Cable Dimensions: 120cm x 10mm
(4' x 0.39")

Bracket and 2 keys included



Neon Coil Cable Lock | 8156

Cable Dimensions: 180cm x 12mm
(6' x 0.47")

Neon Coil Cable Lock | 8157

Cable Dimensions: 180cm x 10mm
(6' x 0.39")

Neon Coil Cable Lock | 8158

Cable Dimensions: 180cm x 8mm
(6' x 0.31")

Neon Cable Lock | 8162

Cable Dimensions: 180cm x 12mm
(6' x 0.47")

Neon Cable Lock | 8163

Cable Dimensions: 120cm x 12mm
(4' x 0.47")

Neon Cable Lock | 8164

Cable Dimensions: 180cm x 10mm
(6' x 0.39")

Neon Cable Lock | 8165

Cable Dimensions: 120cm x 10mm
(4' x 0.39")

Neon Cable Lock | 8166

Cable Dimensions: 180cm x 8mm
(6' x 0.31")

Neon Cable Lock | 8167

Cable Dimensions: 120cm x 8mm
(4' x 0.31")



Neon Combo Coil Cable Lock | 8159

Cable Dimensions: 180cm x 12mm
(6' x 0.47")

Neon Combo Coil Cable Lock | 8160

Cable Dimensions: 180cm x 10mm
(6' x 0.39")

Neon Combo Coil Cable Lock | 8161

Cable Dimensions: 180cm x 8mm
(6' x 0.31")

Neon Combo Cable Lock | 8168

Cable Dimensions: 180cm x 12mm
(6' x 0.47")

Neon Combo Cable Lock | 8169

Cable Dimensions: 120cm x 12mm
(4' x 0.47")

Neon Combo Cable Lock | 8170

Cable Dimensions: 180cm x 10mm
(6' x 0.39")

Neon Combo Cable Lock | 8171

Cable Dimensions: 120cm x 10mm
(4' x 0.39")

Neon Combo Cable Lock | 8172

Cable Dimensions: 180cm x 8mm
(6' x 0.31")

Neon Combo Cable Lock | 8173

Cable Dimensions: 120cm x 8mm
(4' x 0.31")



Neon Padlock | 8240

Shackle Dimensions: 8mm (0.32") D

The Magnum DS system is an innovative leap in design, introducing significant features and benefits over existing locking systems and cylinders.

The world's first spring free patented locking system and cylinder. No more jammed locks

Neon Padlock + Cable | 8241

Shackle Dimensions: 8mm (0.32") D
Cable Dimensions: 120cm x 10mm (4' x 0.39")



Neon Padlock + Chain | 8242

Shackle Dimensions: 8mm (0.32") D
Chain Dimensions: 120cm x 6mm (4' x 0.24")



Neon Combo Padlock | 8243

Shackle Dimensions: 8mm (0.32") D

Small combo locks are perfect for securing skis, snowboards, helmets, leathers or other personal items that don't require maximum security.

- User settable combinations
- Large numbers are easy to see
- Glove friendly raised dials
- Vinyl coated cables protect paint and finishes



Neon Combo Padlock + Cable | 8244

Shackle Dimensions: 8mm (0.32") D
Cable Dimensions: 120cm x 10mm (4' x 0.39")



Neon Combo Padlock + Chain | 8245

Shackle Dimensions: 8mm (0.32") D
Chain Dimensions: 120cm x 6mm (4' x 0.24")

CABLE LOCKS

Light weight, easy to carry and available with either keyed or combination lock mechanisms, cable locks offer bike riders fast, convenient security for medium to low risk situations. Heavy-duty steel cables are permanently forged to lock heads for added security, cables are vinyl coated to protect paint and finishes.

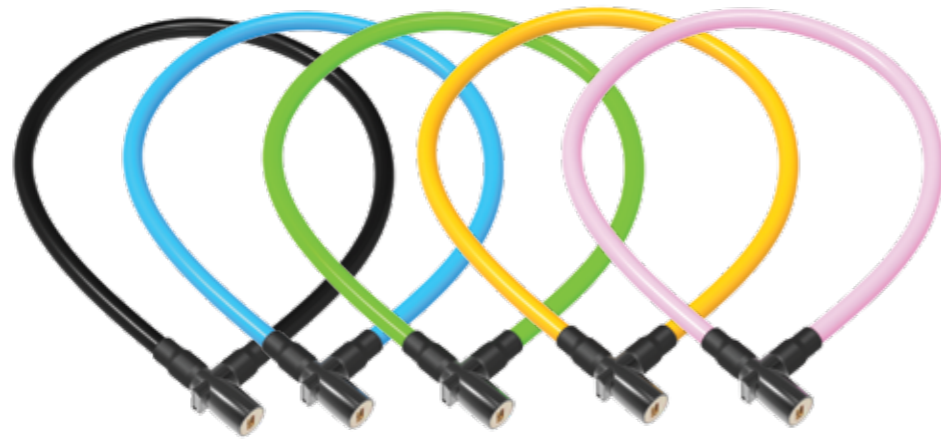

Lightweight Key Cable Lock | 8187

Cable Dimensions: 60cm x 6mm
(1.97' x 0.24")
2 keys included

Lightweight Key Cable Lock | 8188

Cable Dimensions: 80cm x 6mm
(2.62' x 0.24")
2 keys included



Lightweight Combo Cable Lock | 8189

Cable Dimensions: 60cm x 6mm
(1.97' x 0.24")

Lightweight Combo Cable Lock | 8190

Cable Dimensions: 80cm x 6mm
(2.62' x 0.24")

CABLE LOCKS

Light weight, easy to carry and available with either keyed or combination lock mechanisms, cable locks offer bike riders fast, convenient security for medium to low risk situations. Heavy-duty steel cables are permanently forged to lock heads for added security, cables are vinyl coated to protect paint and finishes.

COIL CABLE LOCKS

Light weight, easy to carry and available with either keyed or combination lock mechanisms, coil cable locks offer bike riders fast, convenient security for medium to low risk situations. Heavy-duty steel cables are permanently forged to lock heads for added security, cables are vinyl coated to protect paint and finishes.



Lightweight Key Coil Cable Lock | 8191

Cable Dimensions: 120cm x 8mm
(4' x 0.32")
2 keys included

Lightweight Key Cable Lock | 8192

Cable Dimensions: 150cm x 8mm
(4.92' x 0.32")
2 keys included



Lightweight Combo Coil Cable Lock | 8193

Cable Dimensions: 120cm x 8mm
(4' x 0.32")

Lightweight Combo Cable Lock | 8194

Cable Dimensions: 150cm x 8mm
(4.92' x 0.32")

COIL CABLE LOCKS

Light weight, easy to carry and available with either keyed or combination lock mechanisms, coil cable locks offer bike riders fast, convenient security for medium to low risk situations. Heavy-duty steel cables are permanently forged to lock heads for added security, cables are vinyl coated to protect paint and finishes.

CHAIN LOCKS

Light weight, easy to carry and available with either keyed or combination lock mechanisms, chain locks offer bike riders fast, convenient security for medium to low risk situations. Heavy-duty steel chains are permanently forged to lock heads for added security, chains are vinyl coated to protect paint and finishes.



Lightweight Key Chain Lock | 8195

Chain Dimensions: 60cm x 4mm
(1.97' x 0.16")
2 keys included

Lightweight Key Chain Lock | 8196

Chain Dimensions: 80cm x 4mm
(2.62' x 0.16")
2 keys included



Lightweight Combo Chain Lock | 8197

Chain Dimensions: 60cm x 4mm
(1.97' x 0.16")

Lightweight Combo Chain Lock | 8198

Chain Dimensions: 80cm x 4mm
(2.62' x 0.16")

CHAIN LOCKS

Light weight, easy to carry and available with either keyed or combination lock mechanisms, chain locks offer bike riders fast, convenient security for medium to low risk situations. Heavy-duty steel chains are permanently forged to lock heads for added security, chains are vinyl coated to protect paint and finishes.

eBike

So you have spent a lot of money on your electric bike but what about protecting it?

OnGuard makes the meanest, toughest eBIKE locks in the business. Packed with features inside and out, we deliver the best in security, value, and service. On the inside, OnGuard locks earn the highest safety ratings with double and quad-locking mechanisms, bump-resistant cylinders, and hardened steel shackles and chains. On the outside, our locks are fully-coated to protect your eBike from scratches and to shield internal parts from the elements, while the bright color scheme sends a clear warning to thieves: don't even try! And then there's the extras: lock reminder, carrying bags, five laser cut keys, key-code registration, comprehensive anti-theft programs, limited lifetime warranties and the best sales and customer support team in the business.



Locks shown on this page feature X4P Quattro bolt locking mechanisms



PitBull STD | 8003E

The superior protection of our X4P locking mechanism mated to a standard length 230mm (9.06") 14mm (0.55") TriRadius hardened steel shackle for more locking options.

Shackle Dimensions: 115mm x 230mm (W x H x Diam)
(4.53" x 9.06") x 14mm (0.55") D



PitBull Mini | 8006E

Lighter than Brute Mini but with the advantages of X4P Locking Mechanism. Perfect for fast commuters or bike messengers who are weight sensitive.

Shackle Dimensions: 90mm x 140mm (W x H x Diam)
(3.55" x 5.52") x 14mm (0.55") D



Rottweiler | 8025E

Same features as 5024 with longer 180cm x 25mm (6' x 1") armored steel cable for more locking options.

Cable Dimensions: 180cm x 25mm (6' x 1")



Locks shown on this page feature X4P Quattro bolt locking mechanisms



MASTIFF SERIES | 8019LP ANTI-THEFT PROTECTION OFFER

for power sport \$1001 for bicycle \$3001



Mastiff | 8019E

A short-shackle Boxer U-lock with X4P Quattro Bolt locking mechanism paired to a 3.5-foot long, 10mm (0.39") titanium reinforced, hardened steel hexagonal link chain. Boxer U-lock can also be used alone as a disc lock.

Chain Dimensions: 110cm x 10mm (3.57' x 0.39")
Shackle Diameter: 14mm (0.55")
Hardened Steel



ADDITIONAL FEATURES

5 laser cut keys (1 micro-light and 4 extra grip keys)
Micro-light key projects a bright white beam

MASTIFF SERIES | 8019LP ANTI-THEFT PROTECTION OFFER

for power sport \$1001 for bicycle \$3001



Mastiff | 8019EL

Longer 6' 10mm (0.39") titanium reinforced, hardened steel hexagonal link chain for more locking options. Boxer U-lock can also be used alone as a disc lock.

Chain Dimensions: 180cm x 10mm (6' x 0.39")
Shackle Diameter: 14mm (0.55")
Hardened Steel

ADDITIONAL FEATURES



5 laser cut keys (1 micro-light and 4 extra grip keys)
Micro-light key projects a bright white beam

OnGuard makes the meanest, toughest cuff locks in the business. Packed with features inside and out, we deliver the best in security, value, and service.

The cuff locks offer versatility with lightweight, easy to store capabilities and with a 75mm diameter fitting area inside the cuff that adapts to many areas on your transporter.

On the outside, our locks are fully coated to protect from scratches and with nine different options of single cuff, double cuff or the first ever combo cuff with cable, coil cable or chain you can be sure OnGuard has a cuff lock suitable for all acoustic or electric modern transporters.



Single Cuff Style Chain Lock | 8320
Size: 8mm



Single Cuff Style Coil Cable Lock | 8321
Size: 12mm



Single Cuff Style Cable Lock | 8322
Size: 12mm



Double Cuff Style Combo Chain Lock | 8326
Size: 8mm



Double Cuff Style Combo Coil Cable Lock | 8327
Size: 12mm



Double Cuff Style Combo Cable Lock | 8328
Size: 12mm



Double Cuff Style Chain Lock | 8323
Size: 8mm



Double Cuff Style Coil Cable Lock | 8324
Size: 12mm



Double Cuff Style Cable Lock | 8325
Size: 12mm





OnGuard makes the meanest, toughest eScooter locks in the business. Packed with features inside and out, we deliver the best in security, value, and service. On the inside, OnGuard locks earn the highest safety ratings with double and quad-locking mechanisms, bump-resistant cylinders, and hardened steel shackles and chains. On the outside, our locks are fully-coated to protect your eScooter from scratches and to shield internal parts from the elements, while the bright color scheme sends a clear warning to thieves: don't even try! And then there's the extras: lock reminder, carrying bags, five laser cut keys, key-code registration, comprehensive anti-theft programs, limited lifetime warranties and the best sales and customer support team in the business.

Pat. Pend.



**Electric Scooter
Cable Key Lock | 8287**
Cable Dimensions: 120cm x 12mm
(4' x 0.47")
2 keys included



**Electric Scooter
Cable Key Lock | 8288**
Cable Dimensions: 150cm x 12mm
(4.92' x 0.47")
2 keys included



**Electric Scooter
Cable Key Lock | 8289**
Cable Dimensions: 180cm x 12mm
(6' x 0.47")
2 keys included



**Electric Scooter
Chain Key Lock | 8290**
Chain Dimensions: 90cm x 4mm
(2.95' x 0.16")
2 keys included



**Electric Scooter
Chain Key Lock | 8291**
Chain Dimensions: 120cm x 4mm
(4' x 0.16")
2 keys included



**Electric Scooter
Chain Key Lock | 8292**
Chain Dimensions: 150cm x 4mm
(4.92' x 0.16")
2 keys included



The new OnGuard Scooter Roller lock is a compact, lightweight quick'n'easy solution for locking your scooter during short pit stops and against opportunist thieves. No more need to worry about bringing cumbersome, bulky security as once it's clamped to your steerer this great little lock goes wherever your scooter goes.

The lockable, retractable weatherproof cable can extend for up to a metre so your scooter can be secured to any convenient railing, a post, a tree, cycle stand or even other scooter. Featuring a 4 digit, 10,000 variance click combination gear system that can be easily reset to your own memorable code.



Scooter Roller Cable Lock | 8299

Cable Dimensions: 120cm x 2.5mm (4' x 0.1")



FastLock | 8283

Chain Dimensions: 120cm x 7.5mm (4' x 0.3")



FastLock | 8284

Chain Dimensions: 90cm x 7.5mm (2.95' x 0.3")



FastLock | 8285

Chain Dimensions: 120cm x 5.5mm (4' x 0.22")



FastLock | 8286

Chain Dimensions: 90cm x 5.5mm (2.95' x 0.22")



OnGuard chain locks offer bicycle owners and powersport enthusiasts extra length for locking versatility plus the highest level of security for use in high crime areas. Massive, titanium reinforced hexagonal links render hacksaws and bolt cutters virtually useless while tight inside link dimensions make prying impossible.

Available in a wide variety of chain lengths and link sizes to match your security needs.

OnGuard Chain locks feature:

- Hexagonal and square links present more hardened surfaces than round links making sawing and cutting virtually impossible.
- Titanium surface hardening vastly increase cut and saw resistance.
- Embroidered nylon chain covers won't crack or peel for long lasting beauty.
- Velcro tabs keep cover in place to help protect paint and finishes.
- Comprehensive selection of locks types, chain lengths and link size to exactly match security needs

ADDITIONAL FEATURES



5 laser cut keys
(1 micro-light and 4 extra grip keys)
Micro-light key projects a bright white beam

The new OnGuard Multi-use Zip lock is a cutting-edge, Stainless-steel core, resettable zip-tie style combo lock. Equipped with a 3-digit resettable combination function and 56cm (1.83') length, these lightweight, easy-carry locks have more potential than meets the eye. They can be used separately or daisy-chained together for even greater locking length.



ZIP Lock | 8078

Cable Dimensions: 56cm (1.83')

ZIP Lock Set | 8079

Cable Dimensions: 56cm (1.83')

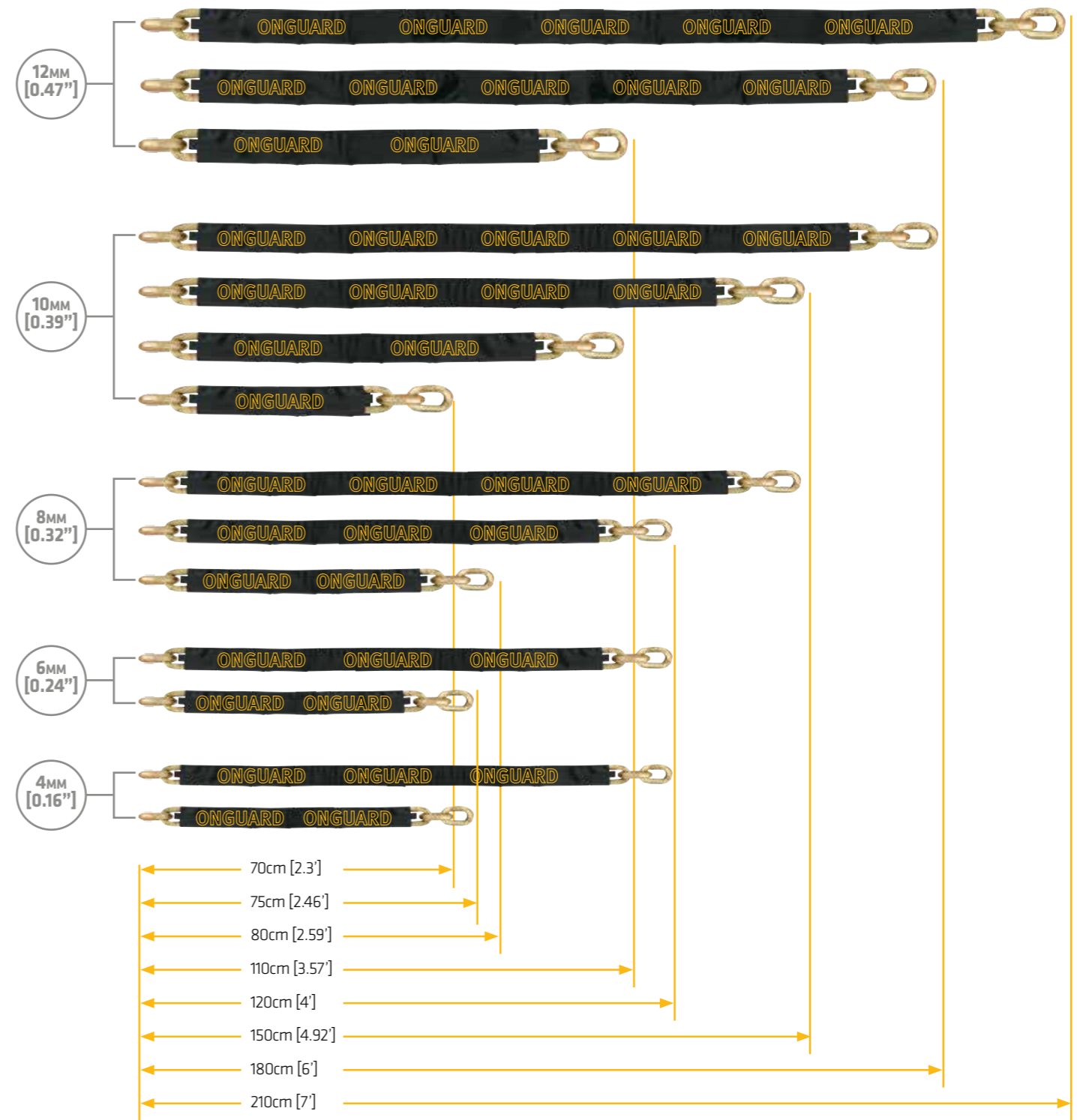

Beast Series	
Model	Size
8226	110cm x 12mm
8227	180cm x 12mm
8228	210cm x 12mm

Mastiff Series					
Model	Size	Model	Size	Model	Size
8229	70cm x 10mm	8233	80cm x 8mm	8236	75cm x 6mm
8230	110cm x 10mm	8234	120cm x 8mm	8237	120cm x 6mm
8231	150cm x 10mm	8235	150cm x 8mm	8238	75cm x 4mm
8232	180cm x 10mm			8239	120cm x 4mm

OnGuard makes the meanest, toughest Ground Anchors in the business perfect for keeping your bike secure in high risk areas. Ideal for use with shackles and heavy duty chains, the shackle is a massive up to 16mm thick and made from hardened steel! This handy lock is also corrosion resistant so suitable for all weather conditions!

- Can be laid flat when not in use making it safe to drive or walk over
- Bolt fixing (included) to enable a secure fixing ideally to concrete



Ground Anchor GOLD | 8312
 Diameter: 16mm (0.63")
 Hardened Steel



Ground Anchor SILVER | 8313
 Diameter: 14mm (0.55")
 Hardened Steel



Ground Anchor BRONZE | 8314
 Diameter: 12mm (0.47")
 Hardened Steel



ONGUARD FLOOR DISPLAY

Great addition to any shop. Dedicated floor space for your customer's favorite security brand. Adaptable to fit all OnGuard products. Can be used back-to-back to create an OnGuard super center. Hooks can be positioned individually and on both sides (25 hooks included). Easy to set up, as parts are mostly pre-assembled.

Slat Wall Sign Holder 8"x24"

- Hold OnGuard signs on standard slat wall
- One sign holder will hold 8"x24" sign, two signs holders will hold 8"x48" sign
- Includes two slat wall mounting hooks
- Easy to set up

Slat Wall Sign Holder 6"x24"

- Hold OnGuard signs on standard slat wall
- One sign holder will hold 6"x24" sign
- Includes two slat wall mounting hooks
- Easy to set up

ONGUARD 8"x48" SIGN

- Slides on two OnGuard 8"x24" slat wall sign holder

ONGUARD 8"x24" SIGN

- Slides on both sides of OnGuard free standing display and on OnGuard 8"x24" slat wall sign holder

ONGUARD 6"x24" SIGN

- Slides on OnGuard 6"x24" slat wall sign holder

ONGUARD 6"x12" SIGN

- Slides on OnGuard 6"x12" slat wall sign holder

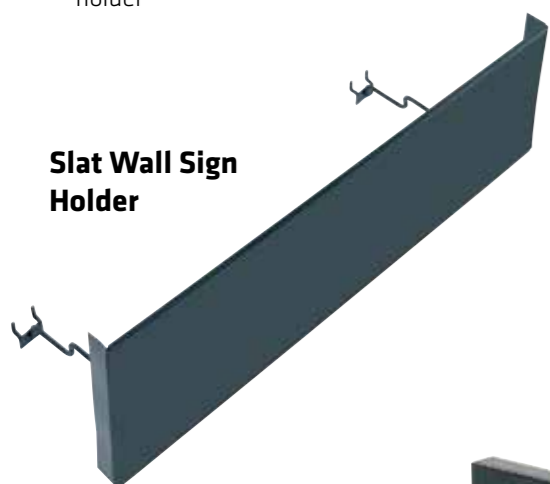

Slat Wall Sign Holder

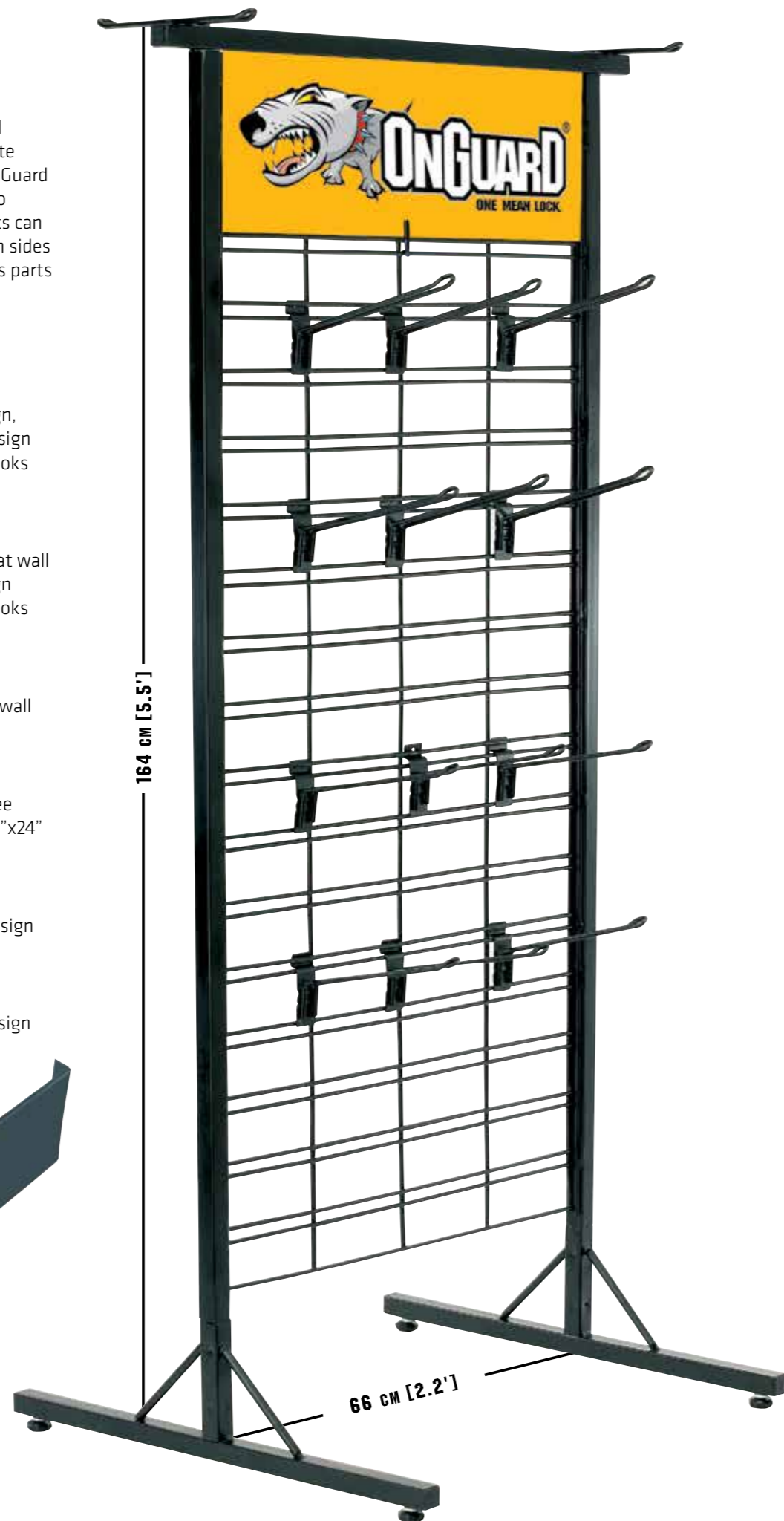

164 CM [5.5']

66 CM [2.2']

ANTI-THEFT PROTECTION OFFER

Anti-theft protection available on all noted U-locks, chains and disc locks for up to three years of coverage. Provides protection and replacement of your bicycle or powersport vehicle up to the designated dollar amount should our product fail when used properly.

LIFETIME WARRANTY

All of our products are warranted to be free from mechanical defects for the lifetime of the product. If a mechanical defect occurs, we'll replace the product - free of charge.



We include 4 keys and 1 Microlight key for night-time use with most of our key locks.



Register your Z-Cylinder key code. If you lose your keys and you have registered them, or know your key number, replacement keys can be sent to you for a minimal fee.

KA

Most OnGuard locks can be keyed alike to each other as well as keyed alike to other OnGuard models that feature the Z-Cylinder™.

ONGUARD SECURITY RATING



Basic Security

This level offers basic theft resistance. Best used in low crime areas, suburban, recreational and rural areas. A quick way to secure your power sport when theft threat is low.



High Security

This level offers high theft resistance. Best used in high crime areas, campuses, suburban and recreational areas. This is a very high level of protection.



Ultimate Security

This level offers the ultimate theft resistance. Best used in major cities, top crime areas, downtown, campuses and urban areas where crime is high. This is your best defense.

Our products have been tested, approved and certified by the most important European test organizations that are dedicated to performing the harshest tests imaginable on locks. And the test results speak for themselves.



ONGUARD
ONE MEAN
LOCK™
onguardlocks



Pitbull Mini DT

Bulldog Combo STD

Brute LS

Beast

Mastiff

Doberman Combo

Doberman

Rottweiler

Akita

ONGUARD

www.onguardlock.com

MAGNUM Industries Limited
Room 2302, 23/F, Lee Garden Two, 28 Yun
Ping Road, Causeway Bay, Hong Kong

Tel: + 852 2159 4850 • Fax: + 852 3007 5109
Email: info@magnum.ws • www.magnum.ws